



Gardner-Westcott Company

Quality Chrome Plated and Stainless Steel Fasteners

AUTOMOTIVE FASTENER CATALOG



**AMERICAN
AND
METRIC
THREADS**

SERVING THE AUTO ENTHUSIAST FOR OVER 4 DECADES

Table of Contents



1

| | |
|---|--------------|
| Index | 2 |
| Technical Information | 3-7 |
| <i>Specifications and Sizes</i> | 4 |
| <i>Style Chart and How to Measure</i> | 5 |
| <i>Thread Identification Fittings</i> | 6 |
| <i>Conversion, Reference and Equivalent Charts</i> | 7 |
| Engine Dress Up Kits | 8-14 |
| <i>Product Emblem Stamped Identification Part Number Chart</i> | 8 |
| <i>Chevrolet and Emblem Stamped Chevy Bowtie, SS, RS, 350 and 454</i> | 10 |
| <i>Pontiac and Oldsmobile Emblem Stamped Arrow, GTO, GT and Olds Rocket</i> | 11 |
| <i>Mopar and Emblem Stamped Chrysler Pentastar, Mopar, Dodge Ram and Hemi</i> | 12 |
| <i>Ford, Flathead and Emblem Stamped Ford Oval, Vintage, V8 and Ford Mustang</i> | 13 |
| <i>6-71 Series Blower Dress Up & Nissan Z Engine Dress Up Kits</i> | 14 |
| Individual Sets | 15-22 |
| <i>Chevrolet</i> | 16 |
| <i>Emblem Stamped Chevy Bowtie, SS, RS, 350 and 454</i> | 17 |
| <i>Emblem Stamped Pontiac, GTO, GT and Oldsmobile Rocket</i> | 17 |
| <i>Ford</i> | 18 |
| <i>Emblem Stamped Ford Oval, V8 and Mustang</i> | 19 |
| <i>Emblem Stamped Flame and Skull</i> | 19 |
| <i>Mopar</i> | 20 |
| <i>Emblem Stamped Mopar, Chrysler Pentastar, Dodge Ram and Hemi</i> | 20 |
| <i>Buick and VW</i> | 20 |
| <i>Interior Screw Sets</i> | 21 |
| Bulk Fasteners- (Chrome, Stainless and Zinc)* Also see Alphabetical Index on Pg. 2 | 23-56 |
| <i>American Thread</i> | 24 |
| <i>Metric Thread</i> | 49 |
| Assortments/Trays | 57-68 |
| Fittings- (Brass and Hand Polished Chrome Plated) | 69-74 |
| Product Display Units- (Floor and Counter Displays) | 75-90 |

TERMS.....Cash or COD company check acceptable unless otherwise specified.

CREDIT..... Applications for open account warrants at least three references of reputable firms that you have dealt with in the past year. Terms are net 30 days from date of invoice. If a customer is in arrears on an open account, future shipments will be processed on a COD basis until credit is restored.

PRICING..... All retail prices shown are suggested only and in no way dictate a set price. Prices are subject to change without notice.

SHIPPING..... We ship UPS and by truck, always collect, with any service charges to be paid by customer.

CLAIMS.....We are not responsible for goods damaged in transit and all claims must be filed with the carrier involved.

RETURNS.....Returns for credit require prior notification and authorization. No returns will be accepted after 30 days from date of invoice.

GUARANTEE.....If any part is found to be defective in workmanship or unsatisfactory in any way, we will replace it or give credit where applicable.

MANUFACTURERS PART NUMBERS OR BRAND NAMES ARE SHOWN FOR REFERENCE ONLY

2015 © Copyright Gardner-Westcott Company Northville, Michigan 48168-9426

Call us toll-free at 1-800-521-9805 or (248)-305-5100 Fax (800)-871-5110 Shop on line at <http://www.gardner-westcott.com>



Alphabetical Index by Part

Bolts

| | American | | | Metric | | |
|---------------------|----------|-----|------|--------|-----|------|
| | Chr. | SS | Zinc | Chr. | SS | Zinc |
| Body Bolts..... | 28 | --- | --- | --- | --- | --- |
| Bumper Bolts..... | --- | 36 | --- | --- | --- | --- |
| Carriage Bolts..... | 28 | 36 | --- | --- | 53 | --- |
| Flange Bolts..... | --- | --- | --- | --- | --- | --- |
| Hex Caps..... | 26 | 40 | 45 | 51 | 53 | 55 |
| Hex Head Sems..... | 28 | --- | --- | --- | --- | --- |
| Spinlock Bolts..... | 28 | --- | --- | --- | --- | --- |
| Step Bolts..... | 28 | --- | --- | --- | --- | --- |

Washers

| | American | | | Metric | | |
|-------------------------------|----------|-----|------|--------|-----|------|
| | Chr. | SS | Zinc | Chr. | SS | Zinc |
| Cup Washers..... | 32 | --- | --- | --- | --- | --- |
| External Lock Washers..... | 31 | 41 | 46 | --- | --- | --- |
| External Countersunk..... | 31 | 41 | --- | --- | --- | --- |
| Internal Lock Washers..... | 31 | 41 | 46 | --- | --- | --- |
| Finishing..... | 32 | 41 | --- | --- | --- | --- |
| Flush..... | 32 | --- | --- | --- | --- | --- |
| Flat Washers..... | 31 | 41 | 46 | 52 | 54 | 56 |
| Flat Washers AN..... | 31 | 41 | --- | --- | --- | --- |
| Flat Washers USS..... | 32 | --- | --- | --- | --- | --- |
| GW Hardened Washers..... | 31 | 41 | --- | --- | --- | --- |
| High Collar Lock Washers..... | 31 | 41 | --- | --- | --- | --- |
| Lock Washers..... | 31 | 41 | 46 | 52 | 54 | 56 |
| Neoprene Backed Washers..... | --- | 42 | --- | --- | --- | --- |
| White Nylon Washers..... | --- | 42 | --- | --- | --- | --- |
| Super Flat Washers..... | 32 | 41 | 46 | 52 | --- | --- |
| Wave Washers..... | --- | --- | --- | 52 | 54 | --- |

Nuts

| | American | | | Metric | | |
|---------------------------------|----------|-----|------|--------|-----|------|
| | Chr. | SS | Zinc | Chr. | SS | Zinc |
| Acorn Nuts..... | 34 | 42 | --- | 52 | --- | --- |
| Acorn Nuts Low Crown..... | 34 | --- | --- | --- | --- | --- |
| Acorn Push on Covers..... | 34 | --- | --- | --- | --- | --- |
| Allen Nuts..... | 33 | --- | --- | --- | --- | --- |
| Castle Nuts..... | --- | 42 | --- | --- | --- | --- |
| Flange Nuts..... | 35 | --- | --- | 52 | --- | --- |
| Flexloc Nuts..... | 33 | --- | --- | --- | --- | --- |
| Hex Nuts..... | 33 | 42 | 46 | 52 | 54 | 56 |
| Jam Flexloc Nuts..... | 33 | --- | --- | --- | --- | --- |
| Jam Nuts Thin..... | 33 | 43 | 46 | 52 | 54 | --- |
| Jam Nylon Insert Lock Nuts..... | 33 | 43 | 46 | 54 | 56 | --- |
| Left Hand Thread..... | 35 | --- | --- | --- | --- | --- |
| Nylon Insert Lock Nuts..... | 33 | 42 | 46 | 52 | 54 | 56 |
| Slotted Nuts..... | 33 | --- | --- | --- | --- | --- |
| Spike Nuts..... | 34 | --- | --- | --- | --- | --- |
| Spin Locks..... | --- | 43 | --- | --- | --- | --- |
| Wing Nuts..... | 35 | --- | --- | --- | --- | --- |
| Wing Nuts Wide Base..... | 35 | --- | --- | --- | --- | --- |

Other Items

| | American | | | Metric | | |
|---------------------------------|----------|-----|------|--------|-----|------|
| | Chr. | SS | Zinc | Chr. | SS | Zinc |
| Assortments..... | 57 | 62 | 63 | 65 | 68 | --- |
| Axle Kits, VW..... | --- | --- | --- | 20 | --- | --- |
| Blower Kit for 6-71 & 8-71..... | 14 | 14 | --- | --- | --- | --- |
| Bulk..... | 23 | 36 | 45 | 49 | 53 | 56 |
| Chevrolet Engine Kits..... | 10 | 10 | --- | 10 | 10 | --- |
| Chevy Bow Tie Product Line..... | 27 | 37 | --- | --- | --- | --- |
| Cotter Pins..... | 35 | 35 | 35 | --- | --- | --- |
| Fittings Brass..... | 69 | --- | --- | --- | --- | --- |
| Fittings Chrome..... | 69 | --- | --- | --- | --- | --- |
| Ford Engine Kits..... | 13 | 13 | --- | --- | --- | --- |
| Ford Flathead Acorn Kit..... | 13 | --- | --- | --- | --- | --- |
| Ford Oval Product Line..... | 29 | 38 | --- | --- | --- | --- |
| Grease Fittings..... | 35 | --- | --- | --- | --- | --- |
| Hinge Pins..... | 21 | 20 | --- | --- | --- | --- |
| Hole Plugs..... | 35 | 42 | --- | --- | --- | --- |
| Hose Clamps..... | --- | 36 | --- | --- | --- | --- |
| Interior Kits..... | 21 | 22 | --- | --- | --- | --- |
| License Plate Kits..... | 16 | --- | --- | --- | --- | --- |
| Line Clamps..... | --- | 36 | --- | --- | --- | --- |
| Metal Trays & Cabinets..... | 58 | --- | --- | --- | --- | --- |
| Mopar Engine Kits..... | 12 | 12 | --- | --- | --- | --- |
| Mopar Emblem Product Line..... | 20 | 20 | --- | --- | --- | --- |
| Muffler Clamps..... | --- | 36 | --- | --- | --- | --- |
| Mustang Front End Kits..... | 18 | --- | --- | --- | --- | --- |
| Nissan 3.0 V-6 Engine Kits..... | --- | --- | --- | 14 | 14 | --- |
| Oldsmobile Engine Kits..... | 11 | 11 | --- | --- | --- | --- |
| Pipe Plugs Allen Style..... | 35 | 42 | --- | --- | --- | --- |
| Pontiac Engine Kits..... | 11 | 11 | --- | --- | --- | --- |
| Product Display Units..... | 73 | 77 | --- | --- | --- | --- |
| Spacers..... | 34 | --- | --- | --- | --- | --- |
| Threaded Rod..... | --- | 42 | --- | --- | --- | --- |
| Throttle Return Springs..... | 28 | 28 | --- | --- | --- | --- |
| Zinc L-9 Bolts..... | --- | --- | 45 | --- | --- | --- |
| Zinc L-9 Washers..... | --- | --- | 46 | --- | --- | --- |
| Zinc L-9 Nuts..... | --- | --- | 46 | --- | --- | --- |

Screws

| | American | | | Metric | | |
|-------------------------------|----------|-----|------|--------|-----|------|
| | Chr. | SS | Zinc | Chr. | SS | Zinc |
| Allen Screws..... | 24 | 39 | 45 | 50 | 53 | --- |
| Button Head Allen Screws..... | 24 | 39 | --- | 50 | 53 | --- |
| Button Head Torx Screws..... | 26 | --- | --- | --- | --- | --- |
| Flat Head Allen Screws..... | 25 | 39 | --- | 50 | 53 | --- |
| 12 Point Screws..... | 25 | --- | --- | 51 | --- | --- |
| Ford Hinge Screws..... | 22 | --- | --- | --- | --- | --- |
| Machine Screws..... | 30 | 44 | 47 | --- | 54 | 48 |
| Sheet Metal Screws..... | 30 | 44 | 47 | --- | 54 | 48 |
| Set Screws..... | --- | 40 | --- | --- | --- | --- |
| Wood Screws..... | 30 | 44 | 47 | --- | --- | 48 |



Inside This Section

| | |
|--|---|
| Specifications and Sizes | |
| American Thread..... | 4 |
| Metric Thread..... | 4 |
| Washer Specifications..... | 4 |
| Wrench Sizes..... | 4 |
| Tensile Requirements..... | 4 |
| Torx and Bit Sizes..... | 4 |
| Style Chart | |
| Bolt and Screws Head Styles..... | 5 |
| How to Measure | |
| Bolt Length..... | 5 |
| Screw Shank..... | 5 |
| Bolt Gage..... | 5 |
| Thread Identification | |
| SAE 45° Flare..... | 6 |
| Inverted Flare..... | 6 |
| Pipe..... | 6 |
| Compression..... | 6 |
| Double Compression..... | 6 |
| Conversion and Reference Charts | |
| Wrench Size..... | 7 |
| Threads per Inch..... | 7 |
| Thread Pitch..... | 7 |
| Metric Conversion..... | 7 |
| Equivalents..... | 7 |





Specifications and Sizes

American Thread

| Size | Decimal Equivalent | Threads Per Inch | | Allen Screw | | Button Heads | | Flat Heads | |
|------------|--------------------|------------------|---------------|------------------|-------------------|------------------|-------------------|------------------|-------------------|
| | | Coarse & Fine | Coarse & Fine | Maximum Key Size | Maximum Head O.D. | Maximum Key Size | Maximum Head O.D. | Maximum Key Size | Maximum Head O.D. |
| #4 | .112 | 40 | 40 | 0/02 | .100 | 1/16 | .212 | 1/16 | .255 |
| #5 | .125 | 40 | 44 | 3/32 | .205 | 5/64 | .238 | 5/64 | .281 |
| #6 | .138 | 32 | 40 | 7/64 | .226 | 5/64 | .262 | 5/64 | .307 |
| #8 | .164 | 32 | 36 | 9/64 | .270 | 3/32 | .312 | 3/32 | .359 |
| #10 (3/16) | .190 | 24 | 32 | 5/32 | .312 | 1/8 | .361 | 1/8 | .411 |
| 1/4 | .250 | 20 | 28 | 3/16 | .375 | 5/32 | .437 | 5/32 | .531 |
| 5/16 | .3125 | 18 | 24 | 1/4 | .469 | 3/16 | .547 | 3/16 | .656 |
| 3/8 | .375 | 16 | 24 | 5/16 | .562 | 7/32 | .656 | 7/32 | .781 |
| 7/16 | .4375 | 14 | 20 | 3/8 | .656 | --- | --- | 1/4 | .844 |
| 1/2 | .500 | 13 | 20 | 3/8 | .750 | 5/16 | .875 | 5/16 | .938 |
| 5/8 | .625 | 11 | 18 | 1/2 | .938 | 3/8 | 1.00 | 3/8 | 1.188 |
| 3/4 | .750 | 10 | 16 | 5/8 | 1.125 | --- | --- | --- | --- |

Torx Size and Bit Sizes

| Torx Size | Bit Size |
|-----------|----------|
| 6/32 | T-10 |
| 8/32 | T-15 |
| 10/24 | T-25 |
| 10/32 | T-25 |
| 1/4 | T-27 |
| 5/16 | T-40 |
| 3/8 | T-45 |
| 1/2 | T-55 |
| 5/8 | T-60 |

Flat Washer Specifications

| Size | Flat Washers | | | AN Washers | | | GW Washers | | |
|------|--------------|-------|-----------|------------|------|-----------|------------|------|-----------|
| | O.D. | I.D. | Thickness | O.D. | I.D. | Thickness | O.D. | I.D. | Thickness |
| #6 | 3/8 | 5/32 | 3/64 | --- | --- | --- | --- | --- | --- |
| #8 | 7/16 | 3/16 | 3/64 | --- | --- | --- | --- | --- | --- |
| #10 | 1/2 | 7/32 | 3/64 | .437 | .203 | 1/32 | --- | --- | --- |
| #12 | 9/16 | 1/4 | 1/16 | --- | --- | --- | --- | --- | --- |
| 1/4 | 5/8 | 9/32 | 1/16 | .500 | .265 | 1/16 | 5/8 | .260 | .08 |
| 5/16 | 11/16 | 11/32 | 1/16 | .562 | .328 | 1/16 | 11/16 | .323 | .09 |
| 3/8 | 13/16 | 13/32 | 1/16 | .625 | .390 | 1/16 | 13/16 | .385 | .09 |
| 7/16 | 59/64 | 15/32 | 1/16 | .750 | .453 | 1/16 | 59/64 | .448 | .10 |
| 1/2 | 1-1/16 | 17/32 | 3/32 | .875 | .516 | 1/16 | 1-1/16 | .510 | .11 |
| 9/16 | 1-3/16 | 19/32 | 3/32 | 1.062 | .578 | 1/16 | --- | --- | --- |
| 5/8 | 1-5/16 | 21/32 | 3/32 | 1.187 | .641 | 1/16 | 1-5/16 | .635 | .12 |
| 3/4 | 1-1/2 | 13/16 | 9/64 | --- | --- | --- | --- | --- | --- |

Metric Flat Washer Specifications

| Size | Flat Washers | | |
|------|--------------|------|-----------|
| | O.D. | I.D. | Thickness |
| 4mm | 9 | 4.3 | 0.8 |
| 5mm | 10 | 5.3 | 1 |
| 6mm | 12 | 6.4 | 11.6 |
| 7mm | 14 | 7.4 | 1.6 |
| 8mm | 16 | 8.4 | 1.6 |
| 10mm | 20 | 10.5 | 2 |
| 12mm | 24 | 13 | 2.5 |
| 14mm | 28 | 15 | 2.5 |
| 16mm | 30 | 17 | 3 |
| 18mm | 34 | 19 | 3 |

American Wrench Sizes (Width across flats) - Hex Bolts

| Wrench Size | Bolt Diameter |
|-------------|---------------|
| 7/16 | 1/4 |
| 1/2 | 5/16 |
| 9/16 | 3/8 |
| 5/8 | 7/16 |
| 3/4 | 1/2 |
| 13/16 | 9/16 |
| 15/16 | 5/8 |
| 1 1/8 | 3/4 |

Metric Wrench Sizes (Width across flats) - Hex Bolts

| Wrench Size | Bolt Diameter |
|-------------|---------------|
| 5.5mm | 3mm |
| 7mm | 4mm |
| 8mm | 5mm |
| 10mm | 6mm |
| 11mm | 7mm |
| 13mm | 8mm |
| 17mm | 10mm |
| 19mm | 12mm |

Metric Thread

| Size | Threads Per Inch | | Allen Screw | | Button Heads | | Flat Heads | |
|------|------------------|---------------|-------------|-------------------|--------------|-------------------|------------|-------------------|
| | Coarse & Fine | Coarse & Fine | Key Size | Maximum Head O.D. | Key Size | Maximum Head O.D. | Key Size | Maximum Head O.D. |
| 3mm | 0.5 | --- | 2.5mm | 5.5mm | 2mm | 5.70mm | 2mm | 6.40mm |
| 4mm | 0.7 | --- | 3mm | 7.0mm | 2.5mm | 7.60mm | 2.5mm | 8.60mm |
| 5mm | 0.8 | --- | 4mm | 8.5mm | 3mm | 9.50mm | 3mm | 10.60mm |
| 6mm | 1.0 | --- | 5mm | 10.00mm | 4mm | 10.50mm | 4mm | 12.60mm |
| 8mm | 1.25 | 1.00 | 6mm | 13.00mm | 5mm | 14.00mm | 5mm | 16.80mm |
| 10mm | 1.50 | 1.25 | 8mm | 16.00mm | 6mm | 17.50mm | 6mm | 21.00mm |
| 12mm | 1.75 | 1.50 | 10mm | 18.00mm | 8mm | 21.00mm | 8mm | 25.00mm |

Tensile Strengths of Material Requirements

| Material | LBS. |
|-----------------|---------|
| Stainless Steel | 85,000 |
| Grade 2 | 85,000 |
| Grade 5 | 120,000 |
| Grade 8 | 150,000 |

Style Chart and Measuring



Styles in Chrome



H= Hex Caps
Chrome Plated

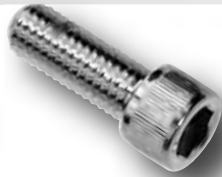

S= Allen Screws
Chrome Plated



B= Button Head
Chrome Plated



N= 12 Point
Chrome Plated



P= Allen Screws
Polished Chrome Plated

Styles in Stainless Steel

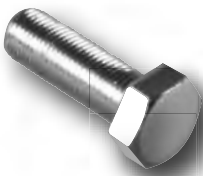

HS= Hex Bolts
Stainless Steel



SS= Allen Screws
Stainless Steel



SB= Button Head
Stainless Steel



HSP= Hex Bolts
Stainless Steel
Polished



SSP= Allen Screws
Stainless Steel
Polished

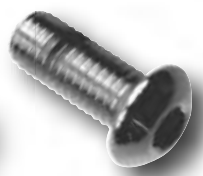

SBP= Button Head
Stainless Steel
Polished

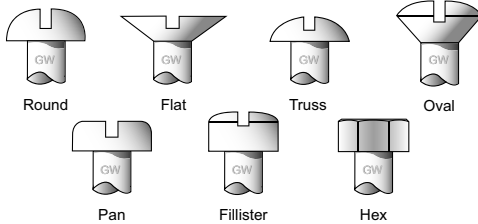

Acorn Nut
and Slotted Stud
Kits



Sheet Metal
Screw

Wood Screw

Machine Screw

How to Measure

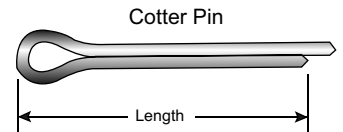
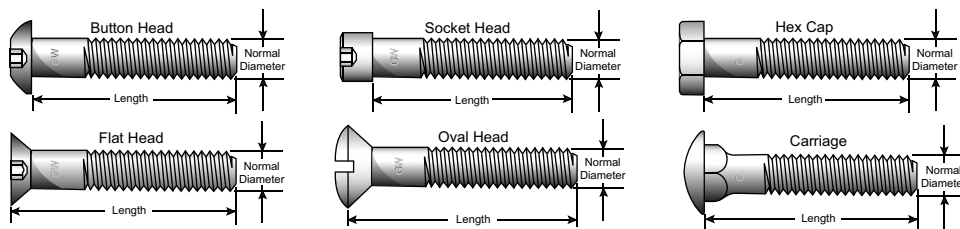

Actual Shank Sizes

To Determine Sizes
of Screws. Lay screw
flat within parallel
lines shown in border

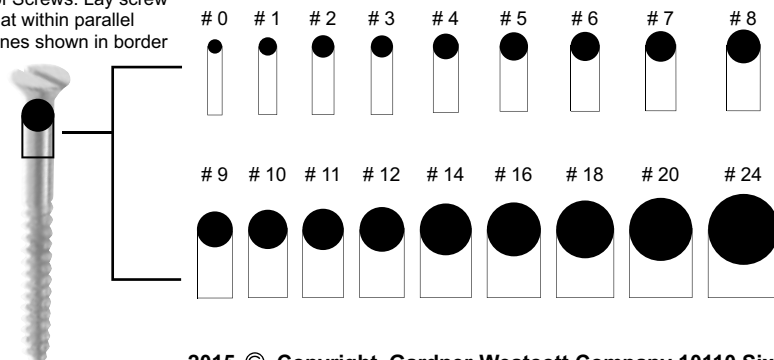

Bolt Gage

Combined American and Metric gage to measure bolts, nuts and screws is an every day necessity to the dealer. These gages are available and can be ordered by **Part # gage**

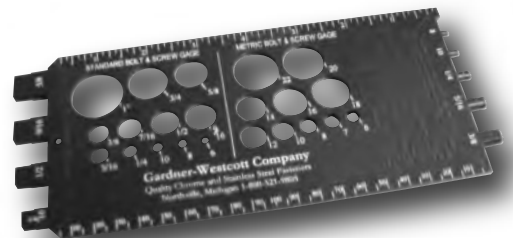



Thread Identification Fittings

Standard Thread Identification

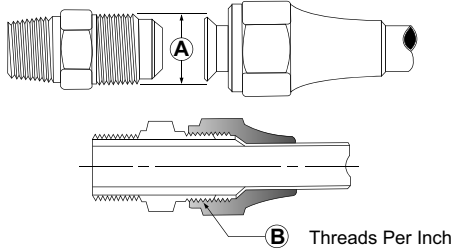

S.A.E 45° Flare

| | | | | | | | | | |
|----------------------|------|------|------|------|-----|-------|-----|-----|--------|
| Tube O.D. | 1/8 | 3/16 | 1/4 | 5/16 | 3/8 | 7/16 | 1/2 | 5/8 | 3/4 |
| Diameter A | 5/16 | 3/8 | 7/16 | 1/2 | 5/8 | 11/16 | 3/4 | 7/8 | 1 1/16 |
| Thread Size B | 24 | 24 | 20 | 20 | 18 | 16 | 16 | 14 | 14 |

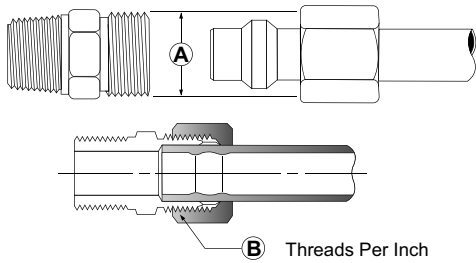

Compression

| | | | | | | | | | | |
|----------------------|------|------|------|------|------|------|-------|-------|-----|-------|
| Tube O.D. | 1/8 | 3/16 | 1/4 | 5/16 | 3/8 | 7/16 | 1/2 | 5/8 | 3/4 | 1 |
| Diameter A | 5/16 | 3/8 | 7/16 | 1/2 | 9/16 | 5/8 | 11/16 | 13/16 | 1 | 1 1/4 |
| Thread Size B | 24 | 24 | 24 | 24 | 24 | 24 | 20 | 18 | 18 | 18 |

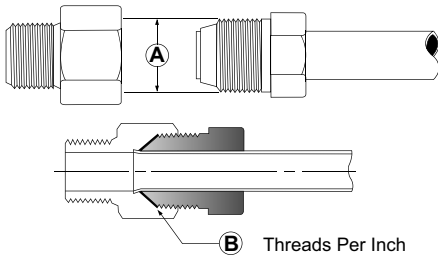

Double Compression

| | | | | | | | |
|----------------------|------|------|------|------|------|------|-------|
| Tube O.D. | 1/8 | 3/16 | 1/4 | 5/16 | 3/8 | 7/16 | 1/2 |
| Diameter A | 5/16 | 3/8 | 7/16 | 1/2 | 9/16 | 5/8 | 11/16 |
| Thread Size B | 24 | 24 | 24 | 20 | 20 | 18 | 16 |

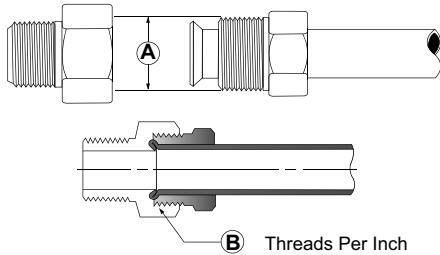

Inverted Flare

| | | | | | | | | | | | |
|----------------------|------|------|------|------|-----|-------|-----|-----|--------|--------|--------|
| Tube O.D. | 1/8 | 3/16 | 1/4 | 5/16 | 3/8 | 7/16 | 1/2 | 5/8 | 3/4 | 7/8 | 1 |
| Diameter A | 5/16 | 3/8 | 7/16 | 1/2 | 5/8 | 11/16 | 3/4 | 7/8 | 1 1/16 | 1 3/16 | 1 5/16 |
| Thread Size B | 28 | 24 | 24 | 20 | 18 | 18 | 18 | 18 | 16 | 16 | 16 |

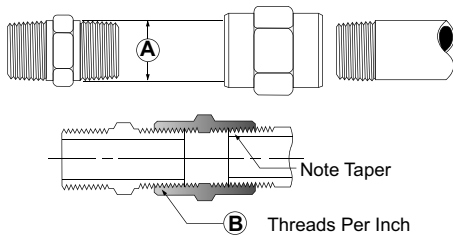

Pipe

| | | | | | | | |
|-------------------------|---------|--------|--------|--------|--------|--------|----------|
| Pipe Size A | 1/16 | 1/8 | 1/4 | 3/8 | 1/2 | 3/4 | 1 |
| Thread Size B | 1/16-27 | 1/8-27 | 1/4-18 | 3/8-18 | 1/2-14 | 3/4-14 | 1-11 1/2 |
| Working Pressure | 1200 | 1200 | 1200 | 1200 | 1200 | 1000 | 1000 |
| Thread OD | 1/4 | 3/8 | 1/2 | 5/8 | 3/4 | 1 | 1 1/4 |

Conversion and Reference Charts



American Equivalents

| Fraction | Decimal | Millimeter |
|------------|--------------|---------------|
| 1/64 | .0156 | 0.397 |
| 1/32 | .0312 | 0.794 |
| 3/64 | .0468 | 1.191 |
| 1/16 | .0625 | 1.588 |
| 5/64 | .0781 | 1.984 |
| 3/32 | .0937 | 2.381 |
| 7/64 | .1093 | 2.778 |
| 1/8 | .1250 | 3.175 |
| 9/64 | .1406 | 3.572 |
| 5/32 | .1562 | 3.969 |
| 11/64 | .1718 | 4.366 |
| 3/16 | .1875 | 4.763 |
| 13/64 | .2031 | 5.159 |
| 7/32 | .2187 | 5.556 |
| 15/64 | .2343 | 5.953 |
| 1/4 | .2500 | 6.350 |
| 17/64 | .2656 | 6.747 |
| 9/32 | .2812 | 7.144 |
| 19/64 | .2968 | 7.541 |
| 5/16 | .3125 | 7.938 |
| 21/64 | .3281 | 8.334 |
| 11/32 | .34375 | 8.731 |
| 23/64 | .3593 | 9.128 |
| 3/8 | .375 | 9.525 |
| 25/64 | .3906 | 9.922 |
| 13/32 | .4062 | 10.319 |
| 27/64 | .4218 | 10.716 |
| 7/16 | .4375 | 11.113 |
| 29/64 | .4531 | 11.509 |
| 15/32 | .4687 | 11.906 |
| 31/64 | .4843 | 12.303 |
| 1/2 | .5000 | 12.700 |
| 33/64 | .5156 | 13.097 |
| 17/32 | .5312 | 13.494 |
| 35/64 | .5468 | 13.891 |
| 9/16 | .5625 | 14.288 |
| 37/64 | .5781 | 14.684 |
| 19/32 | .5937 | 15.081 |
| 39/64 | .6093 | 15.478 |
| 5/8 | .625 | 15.875 |
| 41/64 | .6406 | 16.272 |
| 21/32 | .6562 | 16.669 |
| 43/64 | .6718 | 17.066 |
| 11/16 | .6875 | 17.463 |
| 45/64 | .7031 | 17.859 |
| 23/32 | .7187 | 18.256 |
| 47/64 | .7343 | 18.653 |
| 3/4 | .7500 | 19.050 |
| 49/64 | .7656 | 19.447 |
| 25/32 | .7812 | 19.844 |
| 51/64 | .7968 | 20.241 |
| 13/16 | .8125 | 20.638 |
| 53/64 | .8281 | 21.034 |
| 27/32 | .8437 | 21.431 |
| 55/64 | .8593 | 21.828 |
| 7/8 | .8750 | 22.225 |
| 57/64 | .8906 | 22.622 |
| 29/32 | .9062 | 23.019 |
| 59/64 | .9218 | 23.416 |
| 15/16 | .9275 | 23.813 |
| 61/64 | .9531 | 24.209 |
| 31/32 | .9687 | 24.606 |
| 63/64 | .9843 | 25.003 |
| 1" | 1.000 | 25.400 |

Metric Conversion Chart

| Inches | Millimeters |
|--------|-------------|
| 1/4 | 6mm |
| 5/16 | 8mm |
| 3/8 | 10mm |
| 1/2 | 12mm |
| 5/8 | 16mm |
| 3/4 | 20mm |
| 1 | 25mm |
| 1-3/16 | 30mm |
| 1-3/8 | 35mm |
| 1-9/16 | 40mm |
| 1-3/4 | 45mm |
| 2 | 50mm |
| 2-3/16 | 55mm |
| 2-3/8 | 60mm |
| 2-9/16 | 65mm |
| 2-3/4 | 70mm |
| 3 | 75mm |
| 3-3/16 | 80mm |
| 3-3/8 | 85mm |
| 3-1/2 | 90mm |
| 4 | 100mm |
| 4-3/8 | 110mm |
| 4-3/4 | 120mm |

Technical
Info

Threads Per Inch American

| Coarse | Fine |
|---------|---------|
| 10/24 | 10/32 |
| 1/4-20 | 1/4-28 |
| 5/16-18 | 5/16-24 |
| 3/8-16 | 3/8-24 |
| 7/16-14 | 7/16-20 |
| 1/2-13 | 1/2-20 |
| 9/16-12 | 9/16-18 |
| 5/8-11 | 5/8-18 |
| 3/4-10 | 3/4-16 |

Threads Pitches Metric

| Diameter | Pitch |
|-----------|-------|
| 6mm | 1.0 |
| 8mm | 1.25 |
| 8mm Fine | 1.0 |
| 10mm | 1.50 |
| 10mm Fine | 1.25 |
| 12mm | 1.75 |
| 12mm Fine | 1.50 |
| 14mm | 2.0 |
| 14mm Fine | 1.50 |



Awesome

Product Emblem Stamped Hex Caps Chrome Plated and Polished Stainless Steel



Ford Oval use Part Prefix
11-56250 to order



Chevy Bowtie use Part Prefix
10-56490 to order

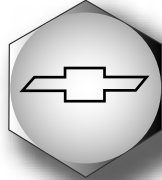

Mopar use Part Prefix
23-56330 to order

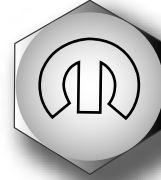

Pontiac Arrow use Part Prefix
12-56490 to order

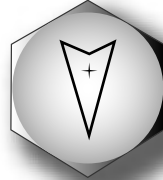

Ford V8 use Part Prefix
24-xxxxx to order



Chevy SS use Part Prefix
13-xxxxx to order



Pontiac GTO use Part Prefix
20-xxxxx to order



Chrysler Pentastar use Part Prefix
21-xxxxx to order



Ford Mustang use Part Prefix
25-xxxxx to order



Chevy RS use Part Prefix
16-xxxxx to order



Pontiac GT use Part Prefix
15-xxxxx to order



Hemi Mopar use Part Prefix
27-xxxxx to order



Flames use Part Prefix
17-xxxxx to order



350 use Part Prefix
18-xxxxx to order



454 use Part Prefix
19-xxxxx to order



Dodge Ram use Part Prefix
22-xxxxx to order



Skulls use Part Prefix
14-xxxxx to order



Olds Rocket use Part Prefix
26-xxxxx to order

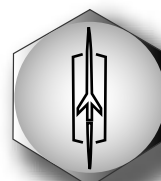

What better way to make a statement!

Select style when ordering:

H = Chrome Plated or HSP = Stainless Steel Polished.

Example: Engine Dress Up Kit Part # XX - XXXXX - **H** or **HSP**

└─ Emblem Prefix Number
└─ Engine Kit Number



Inside This Section

| | |
|--|-----------|
| Chevrolet Engine Sets | |
| <i>Small Block, Big Block, LT1, Vortec and LS1-LS6.....</i> | <i>10</i> |
| Emblem Stamped Chevy Bowtie, SS, RS, 350 & 454 | |
| <i>Small Block, Big Block, LT1, Vortec and LS1-LS6.....</i> | <i>10</i> |
| Pontiac Engine Sets | |
| <i>Engine 326-455 Displacements.....</i> | <i>11</i> |
| Emblem Stamped Pontiac Arrow, GTO and GT | |
| <i>Engine 326-455 Displacements.....</i> | <i>11</i> |
| Oldsmobile Engine Sets | |
| <i>Engine 260-455 Displacements.....</i> | <i>11</i> |
| Emblem Stamped Oldsmobile Rocket | |
| <i>Engine 260-455 Displacements.....</i> | <i>11</i> |
| Chrysler Mopar Engine Sets | |
| <i>Small Block.....</i> | <i>12</i> |
| <i>Big Block.....</i> | <i>12</i> |
| Emblem Stamped Mopar, Chrysler Pentastar, Dodge Ram and Hemi | |
| <i>Small Block.....</i> | <i>12</i> |
| <i>Big Block.....</i> | <i>12</i> |
| Ford Engine Sets | |
| <i>Small Block.....</i> | <i>13</i> |
| <i>Big Block.....</i> | <i>13</i> |
| <i>Flathead.....</i> | <i>13</i> |
| Emblem Stamped Ford Oval, Ford Vintage V8 & Ford Mustang Pony | |
| <i>Small Block.....</i> | <i>13</i> |
| <i>Big Block.....</i> | <i>13</i> |
| 6-71 and 8-71 Mooneyham Blower Dress Up Kits | |
| <i>Big Block.....</i> | <i>14</i> |
| Nissan Z Engine Dress Up Kits | |
| <i>3.0 V-6.....</i> | <i>14</i> |

All automobile manufacturers brand names listed are registered trademarks ®



**Engine
Dress Up Kits**



Chevrolet Engine Dress Up Kits

* For other bolt head styles see the Pick Your Style chart at the top of page 14 in the Individual Applications Section



Chevy Small and Big Block Kits Contain:

Intake Manifold, Valve Cover, Water Neck, Water Pump, Timing Cover, Fuel Pump, Oil Pan, Distributor Hold Down and either Headers or Standard Exhaust Bolts. Washers are supplied where applicable.

Note: Small Block Kit contains the Short Water Pump & Big Block contains the Extended Water Pump.

Also: LS1-LS6 Engine's Kits will Contain: Oil Pan, Header Bolts, Front Cover, Water Crossover, Crank Sender, Water Pump, Valve Cover, Thermostat Housing, Throttle Body, Manifold Hold Down, Kick Down & Fuel Rail Fasteners. **Please specify aluminum or steel valve covers when ordering.**

Engine Dress Up Kit
Part # 56490

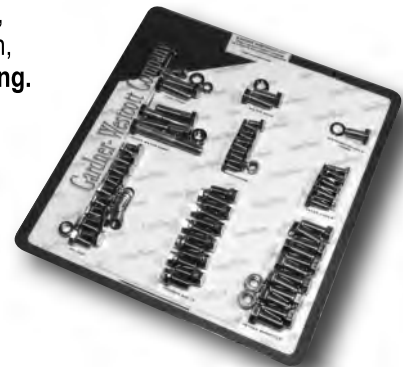

Description

| Description | Part # |
|---|--------|
| Small Block Chevy with Headers..... | 56490 |
| Small Block Chevy with Standard Exhaust Bolts..... | 56492 |
| Big Block Chevy with Headers..... | 56491 |
| LT1 Chevy Engine with Headers..... | 56495 |
| Vortec 350 Chevy Small Block with Headers..... | 56494 |
| LS1-LS6 Engine with Headers (4 bolt valve covers in this kit)..... | 56404 |
| LS1-LS6 Engine with Standard Exhaust Bolts (same as above kit)..... | 56405 |

Chevy Bowtie Stamped Dress Up Kits

Gardner-Westcott is now offering a new and different look for engine dress up bolts, The Chevy Bowtie emblem stamped directly onto the head of the bolts. They are available in decorative Polished Chrome Plated or Stainless Steel versions, in all the sizes needed to give your car that special look. What better way to make a statement than with these unique bolts.

Gardner-Westcott is exclusively licensed by **GM** to produce this product. Same as above engine kits. **Please specify steel or aluminum valve covers when ordering.**

Chevy Bow Tie
Engine Dress Up Kit
10-56492H

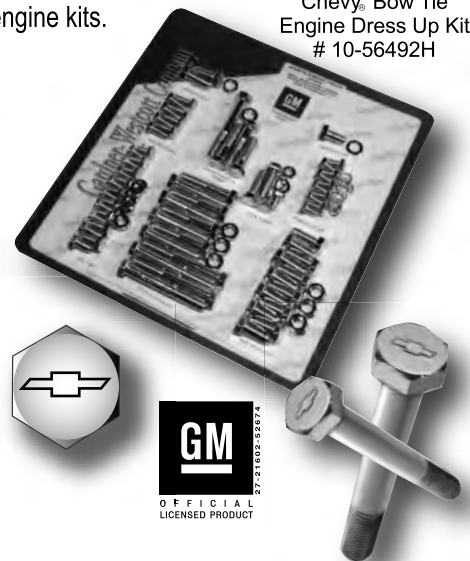

Select style when ordering: **H** = Chrome Plated or **HSP** = Stainless Steel Polished.

Example: Engine Dress Up Kit Part # 10-56490- **H** or **HSP**

Description

| Description | Part # |
|---|----------|
| Small Block Chevy with Headers..... | 10-56490 |
| Small Block Chevy with Standard Exhaust Bolts..... | 10-56492 |
| Big Block Chevy with Headers..... | 10-56491 |
| LT1 Chevy Engine with Headers..... | 10-56495 |
| Vortec 350 Chevy Small Block with Headers..... | 10-56494 |
| LS1-LS6 Engine with Headers (4 bolt valve covers in this kit)..... | 10-56404 |
| LS1-LS6 Engine with Standard Exhaust Bolts (same as above kit)..... | 10-56405 |

Emblem Engine Dress Up Sets Available For

Chevy SS
Part #

- 13-56490
- 13-56492
- 13-56491
- 13-56495
- 13-56494



Chevy RS
Part #

- 16-56490
- 16-56492
- 16-56491
- 16-56495
- 16-56494



Chevy 350
Part #

- 18-56490
- 18-56492
- 18-56491
- 18-56494



Chevy 454
Part #

- 19-56491
- 19-56495



6-71 Blower Engine Dress Up Kit

Part #

Chevy Big Block 6-71 Blower Engine Dress Up Kit..... 56671-P

(This kit will cover the entire top end of a Mooneyham or similar blower unit, Also you can add the finishing touch to your 6-71 Blower by adding (36) - 5/16 chrome hole covers Part # 43570 and (26) - 1/4 chrome hole covers Part # 43569)

Pontiac & Olds Engine Dress Up Kits



Engine Dress Up Kits

* For other bolt head styles see the Pick Your Style chart at the top of page 16 in the Individual Applications Section



Pontiac Engine Kits Contain:

Intake Manifold, Valve Cover, Thermostat Housing, Water Pump, Timing Cover, Timing Cover to Intake Manifold, Fuel Pump, Oil Pan, Distributor Hold Down and Oil Filter Adapter. Washers are supplied where applicable. **Please specify steel or aluminum valve covers.**



Description

Part

| | |
|---|-------|
| Engine Dress Up Kit for 326 - 455 (with no exhaust)..... | 56500 |
| Engine Dress Up Kit for 350, 389, 400, 421 - 455 (with no exhaust)..... | 56505 |

Pontiac ▼

Pontiac Arrow, GTO and GT Engine Dress Up Kits

Dress up your Pontiac Gardner-Westcott is now offering a new and different look for engine dress up bolts, The Pontiac Arrow, GTO and GT emblem stamped directly onto the head of the bolts. They are available in decorative Polished Chrome Plated or Stainless Steel versions, in all the sizes needed to give your car that special look. What better why to make a statement than with these unique bolts. Gardner-Westcott is exclusively licensed by GM to produce this product.

Select style when ordering:

H = Chrome Plated or HSP = Stainless Steel Polished.

Example:

Engine Dress Up Kit Part # 12-56500- H or HSP

Description

Part

| | |
|---|----------|
| Engine Dress Up Kit for 326 - 455 (with no exhaust)..... | 12-56500 |
| Engine Dress Up Kit for 350, 389, 400, 421 - 455 (with no exhaust)..... | 12-56505 |



Pontiac GTO
Part #



20-56500
20-56505

Pontiac GT
Part #



15-56500
15-56505

Oldsmobile



Oldsmobile Engine Kits Contain:

Intake Manifold, Valve Cover, Water Neck, Water Pump, Timing Cover, Fuel Pump, Oil Pan, Distributor Hold Down and Oil Filter Housing. Washers are supplied where applicable. **Please specify steel or aluminum valve covers.**



Description

Part

| | |
|--|-------|
| Engine Dress Up Kit for 260 - 455 (with no exhaust)..... | 56501 |
|--|-------|

Olds Rocket Engine Dress Up Kit

Part

| | |
|--|----------|
| Engine Dress Up Kit for 260 - 455 (with no exhaust)..... | 26-56501 |
|--|----------|



Oldsmobile Rocket use Part Prefix 26-xxxxx to order



Chrysler Engine Dress Up Kits

* For other bolt head styles see the Pick Your Style chart at the top of page 18 in the Individual Applications Section



Gardner-Westcott's Engine Dress Up Kits are available Chrome Plated, Stainless Steel and Polished Stainless Steel. Bolt Styles available include Hex Caps, Allen Screws, Button Head, 12 Point also Mopar, Chrysler Pentastar and Dodge Ram Stamped Hex Cap Bolts.

Chrysler Mopar Small and Big Block Kits Contain:

Please specify steel or aluminum valve covers.

Intake Manifold, Valve Cover, Water Pump, Timing Cover, Fuel Pump, Oil Pan, and either Headers or Standard Exhaust Bolts. Washers are supplied where applicable.

| Description | Part # |
|--|--------|
| Small Block Mopar with Headers..... | 56330 |
| Small Block Mopar with Standard Exhaust..... | 56331 |
| Big Block Mopar with Headers..... | 56332 |



Engine Dress Up Kit Part # 56331-H

Mopar Stamped Dress Up Kits

Dress up your Mopar! Gardner-Westcott Company is now offering a new and different look for engine dress up bolts, The Mopar emblem stamped directly onto the head of the bolts. They are available in decorative Polished Chrome Plated or Stainless Steel versions in all the sizes needed to give your car that special look. What better way to make a Mopar statement than with these unique bolts! **Gardner-Westcott Company** is licensed by Mopar to produce this product



Mopar, Chrysler Pentastar, Dodge Ram and Hemi Kits Contain:

Please specify steel or aluminum valve covers.

Intake Manifold, Valve Cover, Water Pump, Timing Cover, Fuel Pump, Oil Pan, and either Headers or Standard Exhaust Bolts. Washers are supplied where applicable.

Select style when ordering: **H** = Chrome Plated or **HSP** = Stainless Steel Polished.

Example: Engine Dress Up Kit Part # 23-56331- **H** or **HSP**

| Description | Part # |
|--|----------|
| Small Block Mopar with Headers..... | 23-56330 |
| Small Block Mopar with Standard Exhaust..... | 23-56331 |
| Big Block Mopar with Headers..... | 23-56332 |

Emblem Engine Dress Up Sets Available in:

Chrysler Pentastar Part #

21-56330
21-56331
21-56332



Dodge Ram Part #

22-56330
22-56331
22-56332



Hemi Mopar Part #

27-56330
27-56331
27-56332



Engine Dress Up Kit Part # 23-56331-HSP

Ford Engine Dress Up Kits



* For other bolt head styles see the Pick Your Style chart at the top of page 16 in the Individual Applications Section



H= Hex Cap Chrome Plated

HSP= Hex Cap Stainless Steel Polished

P= Polished Chrome Plated Knurles Removed

SP= Polished Stainless Steel Knurles Removed

B= Button Head Chrome Plated

N= 12 Point Chrome Plated

Gardner Westcott's Engine Dress Up Kits are available Chrome Plated, Stainless Steel and Polished Stainless Steel. Bolt Styles available include Hex Caps, Allen Screws, Button Head, 12 Point, Ford Oval, Ford V8 & Ford Mustang Stamped Hex Cap Bolts.

Ford 289, 302 only Kits Contain:

Intake Manifold, Valve Cover, Filler Neck, Timing Cover, Fuel Pump, Oil Pan, and either Headers or Standard Exhaust Bolts. Washers are supplied where applicable. **Note: Water Pump Bolts are not included.**

Description

| | Part # |
|--|--------|
| 289, 302 Ford with Headers..... | 56250 |
| 289, 302 Ford with Standard Exhaust..... | 56251 |
| 390, 428 Ford with Headers..... | 56253 |
| 429, 460 Ford with Headers..... | 56254 |
| 351 Cleveland..... | 56255 |
| 400 Modified..... | 56256 |

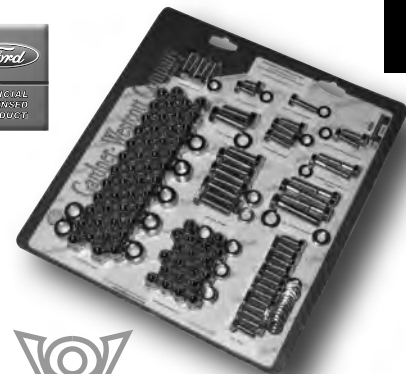

Description

| | Part # |
|---|-------------|
| 8BA 49-53 Chrome acorn covers for both Cylinder Heads and Intake Manifold..... | 56263-AC |
| 8BA 49-53 Chrome acorn nuts for both Cylinder Heads and Intake Manifold along with Stamped V8 Hex Caps for Timing Cover, Coil Bracket, Fan Shaft, Distributor Hold Down, Coolant Neck, Water Pump, Fuel Pump Stand Off, Stand Off to Fuel Pump, Oil Filter Mount and Oil Pan..... | 24-56264-AC |



Flathead Engine Dress Up Kit Part # 24-56264-AC

Ford Stamped Engine Dress Up Kits

Dress up your Ford! We now offer a new and different look for engine dress up bolts, The Ford Oval emblem stamped directly onto the head of the bolts. They are available in decorative Polished Chrome Plated or Stainless Steel versions in all the sizes needed to give your car that special look. What better way to make a Ford statement than with these unique bolts.

Ford Oval, V8 & Mustang Emblem Stamped Dress Up Kits

Ford Oval Engine Dress Up Kit Part # 11-56256-HSP

Description

| | Part # |
|--|----------|
| 289, 302 Ford with Headers..... | 11-56250 |
| 289, 302 Ford with Standard Exhaust..... | 11-56251 |
| 390, 428 Ford with Headers..... | 11-56253 |
| 429, 460 Ford with Headers..... | 11-56254 |
| 351 Cleveland..... | 11-56255 |
| 400 Modified with Standard Exhaust..... | 11-56256 |



Emblem Engine Dress Up Sets Available in:

Ford V8
Part #

Ford Mustang
Part #

- 24-56250
- 24-56251
- 24-56253
- 24-56254
- 24-56255
- 24-56256



- 25-56250
- 25-56251
- 25-56253
- 25-56254
- 25-56255
- 25-56256



Select style when ordering:

H = Chrome Plated or **HSP** = Stainless Steel Polished.

Example:

Engine Dress Up Kit Part # 11-56250- **H** or **HSP**



6-71 Blower Dress Up Kit

Gardner-Westcott Company has created a dress-up kit especially for the very popular 6-71 and 8-71 supercharger blower. Now you can dress up your show blower with either chrome or polished chrome allen fasteners. We also have an accessory kit of chrome hole plugs, that will add that clean definitive touch and really set off your supercharger. The kit contains fasteners for the top end of a 6-71 or 8-71 series blower, which includes; the Upper Pulley, Bearing Support Front Cover Plate, Front Cover, Bearing Rear Cover Plate, Bearing Plate, Upper Plenum to Intake, Thermostat Housing and Burp Valve.



S= Allen Screws
Chrome Plated

P= Allen Screws
Polished Chrome
Plated
Knurles Removed

SS= Allen Screws
Stainless Steel

SSP= Allen Screws
Stainless Steel
Polished
Knurles Removed

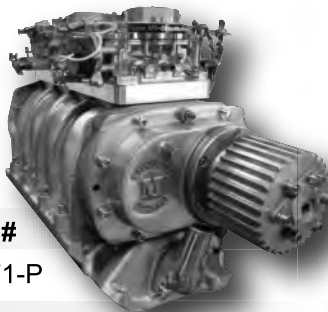

Blower Dress Up Kit
Part # 56671-P

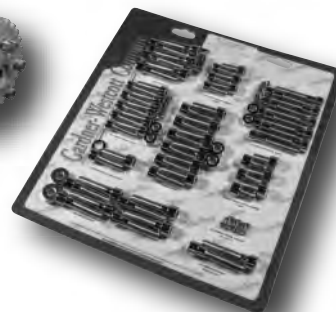

Blower Dress Up Kit

Part #

Big Block Chevy 6-71 thru 8-71 - (Mooneyham Blower)..... 56671-P

Optional Hole Plugs to detail Allen Screws

Part #

5/16 Size for 3/8 Allens - (36 required)..... 43570

1/4 Size for 5/16 Allens - (26 required)..... 43569

NOTE: Some blower configurations may differ, in which case we can offer complete american and metric bulk assortments to detail any engine build or custom project.

Nissan Dress Up Kits

Nissan Z 3.0 V-6 Engine Dress Up Kits

Fits 1984 - 89

Style Description

- HSPA** = Hex Cap Polished Stainless Steel with Polished Stainless Steel Rubber Backed Washers
- HA** = Hex Cap Chrome with Polished Stainless Steel Rubber Backed Washers
- HSP** = Hex Cap Polished Stainless Steel
- H** = Hex Cap Chrome Plated
- P** = Polished Chrome Allens Screws
- SSP** = Stainless Steel Polished Allen Screws
- C** = Chrome Plated Flat Head Allen Screws
- B** = Button Head Chrome Plated Allen Screws
- BSP** = Button Head Stainless Steel Polished Allen Screws



Valve Covers
56102-H



Manifold Cover
56103-C

| Valve Cover | Part # |
|------------------|------------|
| Valve Cover..... | 56102-H |
| Valve Cover..... | 56102-HA |
| Valve Cover..... | 56102-HSP |
| Valve Cover..... | 56102-HSPA |
| Valve Cover..... | 56102-P |
| Valve Cover..... | 56102-SSP |

| Fender Bolts | Part # |
|-------------------|------------|
| Fender Bolts..... | 56104-B |
| Fender Bolts..... | 56104-BSP |
| Fender Bolts..... | 56104-H |
| Fender Bolts..... | 56104-HA |
| Fender Bolts..... | 56104-HSP |
| Fender Bolts..... | 56104-HSPA |



Fender Bolts
56104-H



Hood Hinge & Latch
56105-H

| Manifold Cover | Part # |
|---------------------|------------|
| Manifold Cover..... | 56103-C |
| Manifold Cover..... | 56103-FASP |

| Hood Hinge | Part # |
|-------------------------|------------|
| Hood Hidge & Latch..... | 56105-H |
| Hood Hidge & Latch..... | 56105-HA |
| Hood Hidge & Latch..... | 56105-HSP |
| Hood Hidge & Latch..... | 56105-HSPA |



Inside This Section

| | |
|--|-----------|
| <i>Chevrolet.....</i> | <i>16</i> |
| <i>Emblem Stamped Chevy Bow Tie, SS, RS, 350 and 454.....</i> | <i>17</i> |
| <i>Emblem Stamped Pontiac, GTO and GT.....</i> | <i>17</i> |
| <i>Ford.....</i> | <i>18</i> |
| <i>Emblem Stamped Ford Oval, Ford V8 and Ford Mustang.....</i> | <i>19</i> |
| <i>Emblem Stamped Flame and Skull.....</i> | <i>19</i> |
| <i>Mopar.....</i> | <i>20</i> |
| <i>Emblem Stamped Mopar, Chrysler Pentastar, Dodge Ram and Hemi.....</i> | <i>20</i> |
| <i>Buick.....</i> | <i>20</i> |
| <i>VW.....</i> | <i>20</i> |
| <i>Interior Screw Sets.....</i> | <i>21</i> |

Individual Sets

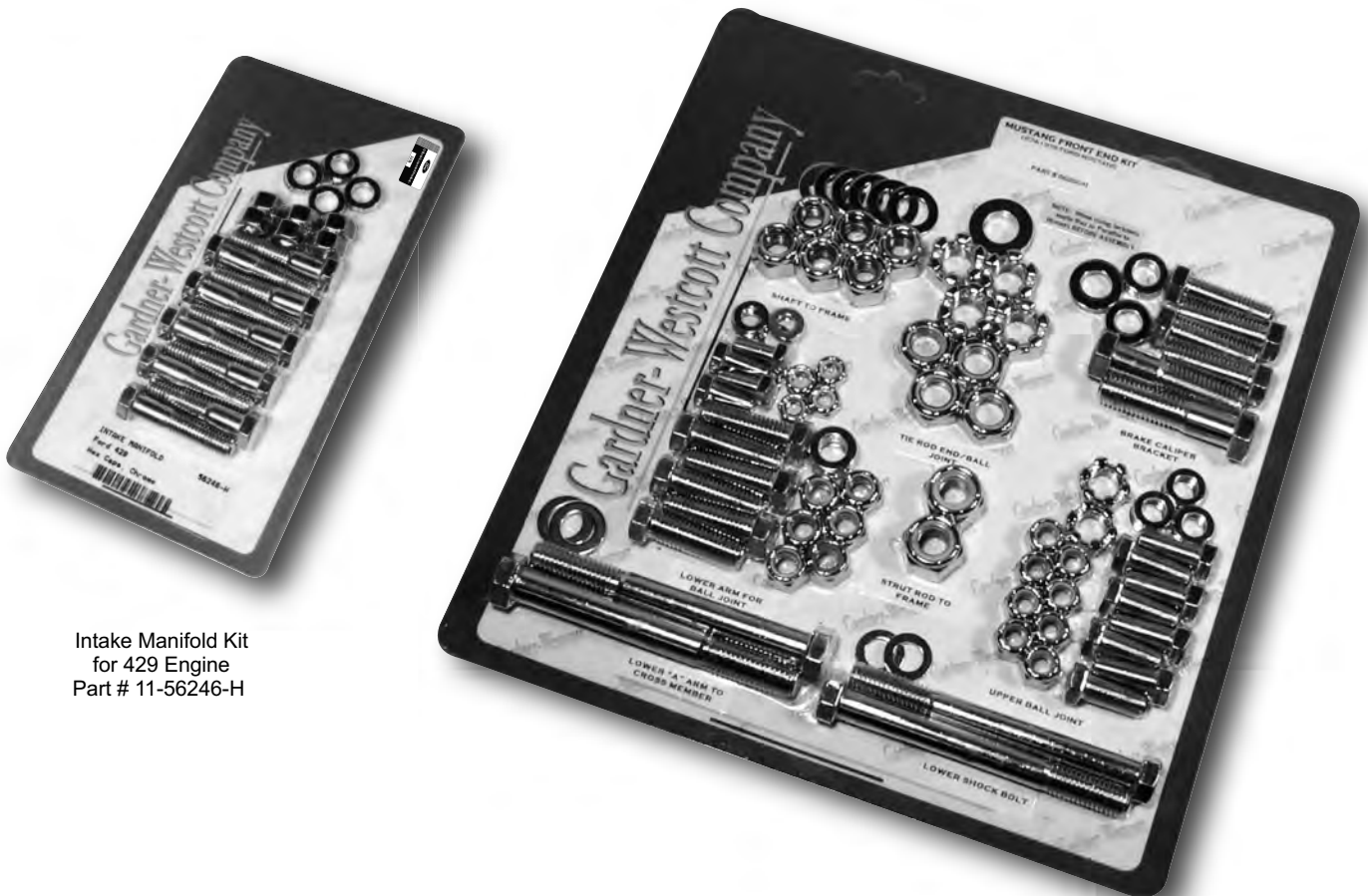

Intake Manifold Kit
for 429 Engine
Part # 11-56246-H

Mustang Front End Kit
Part # 56260-H



Chevrolet Individual Sets

Pick your style of fastener

Style



H= Hex Caps Chrome Plated S= Allen Screws Chrome Plated B= Button Head Chrome Plated N= 12 Point Chrome Plated P= Allen Screws Polished Chrome Plated HS= Hex Bolts Stainless Steel SS= Allen Screws Stainless Steel SB= Button Head Stainless Steel HSP= Hex Bolts Stainless Steel Polished SSP= Allen Screws Stainless Steel Polished SBP= Button Head Stainless Steel Polished

| Description | Part # |
|--|---------|
| Alternator Jam Nut Chrome..... | 15574 |
| Axle Truck 10 Bolt, 2 & 4 Wheel Drive..... | 56458 |
| Axle Truck 12 Bolt, 2 & 4 Wheel Drive..... | 56459 |
| Bell Housing..... | 56484 |
| Bumper Bolt Kit 67 - 69 Camaro Frt..... | 56850 |
| Bumper Bolt Kit 67 - 69 Camaro Rr..... | 56851 |
| Bumper Bolt Kit 67 - 69 Camaro Frt, (w/washers & nuts).. | 56852 |
| Bumper Bolt Kit 67 - 69 Camaro Rr, (w/washers & nuts)... | 56853 |
| Carburetor Stud Kits with 4 Studs, (w/washers & nuts) | |
| 1 3/8" overall length Stainless Steel..... | 4086 |
| 1 1/2" overall length Stainless Steel..... | 4087 |
| 2" overall length Stainless Steel..... | 4088 |
| 1 3/8" overall length Chrome Plated..... | 4083 |
| 1 1/2" overall length Chrome Plated..... | 4084 |
| 2" overall length Chrome Plated..... | 4085 |
| Coil Mount to Block..... | 56478 |
| Exhaust Manifold..... | 56477 |
| Exhaust Manifold Studs Standard in Stainless Steel | |
| 3/8-16 x 2 1/4" sold each..... | 88347 |
| 3/8-16 x 2 3/4" sold each..... | 88349 |
| 3/8-16 x 3" sold each..... | 88348 |
| Fan Spacer Bolts Extended..... | 56457 |
| Fan Spacer Bolts Short..... | 56456 |
| Front Cover Bolts..... | 56464 |
| Fuel Pump..... | 56460 |
| Head Bolt Washers..... | 56473W |
| Head Bolts Outside Small Block..... | 56472 |
| Head Bolts Outside Big Block..... | 56493 |
| Head Bolts Outside Aluminum Small Block..... | 56480 |
| Header Bolts LT-1 Engine..... | 56498 |
| Header Bolts 350 Vortec Engine 1"..... | 56702 |
| Header Bolts Big Block..... | 56488 |
| Header Bolts, (small 3/8" Hex 3/4" long)..... | 56415-H |
| Header Bolts Small Block, (small 3/8" Hex 1" long)..... | 56416-H |
| Header Bolts Small Block 1" Long..... | 56418 |
| Header Bolts Small Block..... | 56461 |
| Header Bolts LS1 - LS6..... | 56406 |
| Hood Hinge Bolts..... | 56481 |
| Injection Mount LT-1 Engine..... | 56499 |
| Intake Manifold V6 1977 to 1981..... | 56421 |

| Description | Part # |
|---|------------|
| Intake Manifold LT-1 Engine..... | 56402 |
| Intake Manifold 350 Vortec Engine..... | 56700 |
| Intake Manifold Big Block..... | 56479 |
| Intake Manifold Small Block..... | 56469 |
| Intake Manifold Small Block (except undersized 3/8" Hex Chrome)..... | 56469-UH |
| Intake Manifold Small Block (except undersized 3/8" Hex Stainless Polished)..... | 56469-UHSP |
| License Plate Screw Kit Chrome Plated..... | 56220 |
| License Plate Kit for Plastic inserts..... | 56401 |
| Mag Wheel Washers Chrome (Sold Each)..... | 23578 |
| Mag Wheel Washers Stainless (Sold Each)..... | 75578 |
| Oil Pan LT-1 Engine..... | 56497 |
| Oil Pan Small Block..... | 56465 |
| Oil Pan Big Block..... | 56487 |
| Rear Cover 10 Bolt..... | 56475 |
| Rear Cover 12 Bolt..... | 56476 |
| Timing Cover LT-1 Engine..... | 56400 |
| Timing Cover 502 Big Block..... | 56455 |
| Transmission Pan Cover 700R4..... | 56236 |
| Transmission Pan Small Block..... | 56474 |
| Tune Port Injection System..... | 56417 |
| Valve Cover Flange Small Block..... | 56410 |
| Valve Cover Acorns and Studs..... | 56462A |
| Valve Cover LT-1 Engine..... | 56403 |
| Valve Cover 350 Vortec Engine..... | 56701 |
| Valve Cover Aluminum Big Block..... | 56486 |
| Valve Cover Aluminum Small Block..... | 56466 |
| Valve Cover Steel Big Block..... | 56485 |
| Valve Cover Steel Small Block..... | 56463 |
| Valve Cover Long Big Block..... | 56489 |
| Valve Cover LS1 - LS6 (with coil packs)..... | 56407 |
| Valve Cover Spike Nut & Studs (Steel)..... | 56462-X1 |
| Valve Cover Spike Nut & Studs (Aluminum)..... | 56462-X2 |
| Water Neck 45°..... | 56471 |
| Water Neck 90°..... | 56470 |
| Water Pump LT-1 Engine..... | 56496 |
| Water Pump Extended..... | 56467 |
| Water Pump Short Small Block..... | 56468 |

Individual Sets for Chevy®



You can also order the listed Individual sets with the Emblems Stamped on the Hex Caps as shown below by using the Part Prefix associated with that emblem.



Chevy Bowtie
use Part Prefix
10-xxxxx to order



Chevy SS
use Part Prefix
13-xxxxx to order



Chevy RS
use Part Prefix
16-xxxxx to order



350
use Part Prefix
18-xxxxx to order



454
use Part Prefix
19-xxxxx to order

Select style when ordering: H = Chrome Plated or HSP = Stainless Steel Polished.
Example: Engine Dress Up Kit Part # 10-56458- H or HSP

Individual Sets

| Description | Part # |
|--|----------|
| Axle Truck 10 Bolt, 2 & 4 Wheel Drive..... | 10-56458 |
| Axle Truck 12 Bolt, 2 & 4 Wheel Drive..... | 10-56459 |
| Bell Housing..... | 10-56484 |
| Coil Mount to Block..... | 10-56478 |
| Exhaust Manifold..... | 10-56477 |
| Fan Spacer Bolts Extended..... | 10-56457 |
| Fan Spacer Bolts Short..... | 10-56456 |
| Fuel Pump..... | 10-56460 |
| Head Bolts- Outside Sm. Block..... | 10-56472 |
| Head Bolts- Outside Big Block..... | 10-56493 |
| Header Bolts LT-1 Engine..... | 10-56498 |
| Header Bolts 350 Vortec Engine..... | 10-56702 |
| Header Bolts Big Block..... | 10-56488 |
| Header Bolts Sm. Block 1" Long..... | 10-56418 |
| Header Bolts Sm. Block..... | 10-56461 |
| Header Bolts LS1-LS6..... | 10-56406 |
| Hood Hinge Bolts..... | 10-56481 |
| Hood Hinge Bolts 1955 to 1957..... | 10-56482 |
| Hood Hinge Bushing Kits GM (late model)..... | 10-56419 |
| Injection Mount LT-1 Engine..... | 10-56499 |
| Intake Manifold LT-1 Engine..... | 10-56402 |
| Intake Manifold 350 Vortec Engine..... | 10-56700 |
| Intake Manifold Big Block..... | 10-56479 |
| Intake Manifold Sm. Block..... | 10-56469 |

| Description | Part # |
|--|----------|
| License Plate Kit..... | 10-56401 |
| Oil Pan LT-1 Engine..... | 10-56497 |
| Oil Pan Sm. Block..... | 10-56465 |
| Oil Pan Big Block..... | 10-56487 |
| Rear Cover 10 Bolt..... | 10-56475 |
| Rear Cover 12 Bolt..... | 10-56476 |
| Timing Cover Bolts..... | 10-56464 |
| Timing Cover LT-1 Engine..... | 10-56400 |
| Transmission Pan Cover 700R4..... | 10-56236 |
| Transmission Pan Sm. Block..... | 10-56474 |
| Valve Cover Flange Bolts Sm. Block..... | 10-56412 |
| Valve Cover LT-1 Engine..... | 10-56403 |
| Valve Cover 350 Vortec Engine..... | 10-56701 |
| Valve Cover Aluminum Big Block..... | 10-56486 |
| Valve Cover Aluminum Sm. Block..... | 10-56466 |
| Valve Cover Steel Big Block..... | 10-56485 |
| Valve Cover Steel Sm. Block..... | 10-56463 |
| Valve Cover LS1-LS6 (with coil packs)..... | 10-56407 |
| Water Neck 45°..... | 10-56471 |
| Water Neck 90°..... | 10-56470 |
| Water Pump LT-1 Engine..... | 10-56496 |
| Water Pump Extended..... | 10-56467 |
| Water Pump Short Sm. Block..... | 10-56468 |

Pontiac ▼

Example: Engine Dress Up Kit Part # 12-56500- H or HSP



Pontiac Arrow
use Part Prefix
12-xxxxx to order



Pontiac GTO
use Part Prefix
20-xxxxx to order



Pontiac GT
use Part Prefix
15-xxxxx to order

| Description | Part # |
|---|----------|
| 326-455 Engine Dress Up Kit..... | 56500 |
| 350,389,400 & 455 H.O. Exhaust Kit..... | 56517 |
| 326-455 Intake Manifold..... | 56522 |
| 326-455 Intake Manifold..... | 56522-HS |
| 350-455 Intake Manifold..... | 56521 |
| Water Pump..... | 56533 |
| 350-455 Timing Cover..... | 56515 |
| 350, 389 Oil Pan..... | 56531 |

Part Numbers Listed here are Individual Kits w/o Emblem Stamped Prefix Numbers.

| Description | Part # |
|----------------------------------|---------|
| 326, 455 Oil Pan..... | 56532 |
| 350 Aluminum Value Cover..... | 56529 |
| 326 Valve Cover..... | 56528 |
| 326 Steel Valve Cover..... | 56258-H |
| 326 Timing Cover..... | 56516 |
| Fuel Pump..... | 56519 |
| 350-455 Engine Dress Up Kit..... | 56505 |



Pick your style of fastener



H= Hex Caps Chrome Plated S= Allen Screws Chrome Plated B= Button Head Chrome Plated N= 12 Point Chrome Plated P= Allen Screws Polished Chrome Plated HS= Hex Bolts Stainless Steel SS= Allen Screws Stainless Steel SB= Button Head Stainless Steel HSP= Hex Bolts Stainless Steel Polished SSP= Allen Screws Stainless Steel Polished SBP= Button Head Stainless Steel Polished

Description

Part

| | |
|---|----------|
| Alternator Jam Nut Chrome (Sold Each)..... | 15574 |
| Bed Bolt Set - 1953 to 1956 (F-100)..... | 56252 |
| Cylinder Head Flathead (Chrome Acorn Covers)..... | 56259-AC |
| Exhaust Manifold 289 and 302..... | 56248 |
| Fuel Pump 289 and 302..... | 56240 |
| Fuel Pump 351 Cleveland and 400..... | 56243 |
| Header Bolts (3/8-16 x 1 with 7/16 wrench)..... | 56223 |
| Header Bolts (3/8-16 x 1 with 3/8 wrench)..... | 56200 |
| Intake Manifold 429..... | 56246 |
| Intake Manifold FE Engine..... | 56245 |
| Intake Manifold 289..... | 56221 |
| Intake Manifold 351 Cleveland..... | 56222 |
| Intake Manifold Flathead (Chrome Acorn Covers)..... | 56257-AC |
| Mustang Front End Kit..... | 56260 |
| Rack Bolts 5/8 x 4" (Grade 8 Chrome Plated)..... | 56261 |
| Oil Pan 289 and 302..... | 56231 |
| Oil Pan 351 Cleveland and 400..... | 56232 |
| Oil Pan 390 and 428..... | 56233 |
| Tie Rod Nuts 11/16-18 (Stainless Left Hand Thread, sold each)..... | 67561-L |
| Tie Rod Nuts 11/16-18 (Stainless Right Hand Thread, sold each)..... | 67561-R |
| Timing Cover 289 and 302..... | 56242 |
| Timing Cover 390..... | 56244 |
| Transmission Pan Cover C4..... | 56235 |
| Transmission Pan Cover C6..... | 56234 |
| Valve Cover Aluminum 289 and 302..... | 56227 |
| Valve Cover Aluminum 351 Cleveland..... | 56228 |
| Valve Cover Steel 289..... | 56224 |
| Valve Cover Steel 351 Cleveland..... | 56225 |
| Valve Cover Steel 428..... | 56226 |
| Water Neck..... | 56230 |

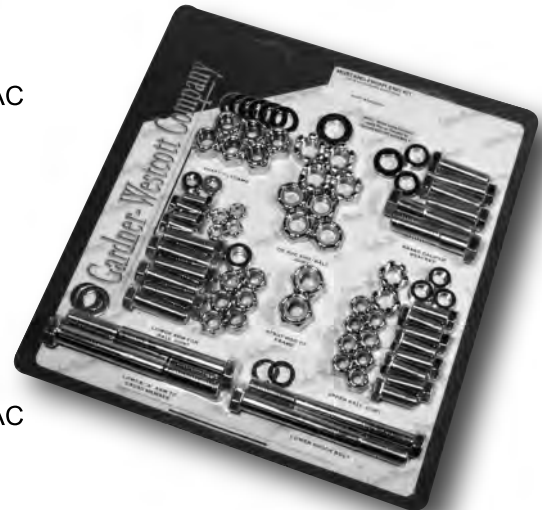

Mustang Front End Kit
Part # 56260-H



Cylinder Head
8BA 49-53 Ford Flathead
Part # 56250-AC

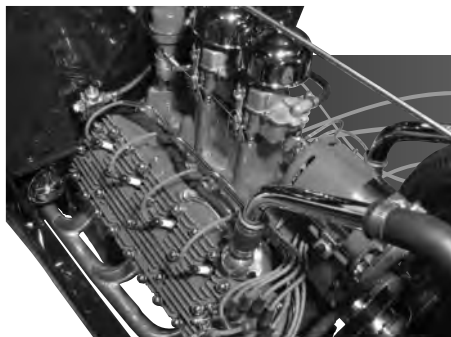

Flatheads



Individual Sets for Ford



You can also order the listed Individual Applications sets with the Emblems Stamped on the Hex Caps as shown below by using the Part Prefix associated with that emblem.

Select style when ordering:

H = Chrome Plated or **HSP** = Stainless Steel Polished.

Example: Engine Dress Up Sets Part # $\overbrace{\text{XX}}^{\text{Emblem Prefix Number}} - \overbrace{\text{XXXXX}}^{\text{Individual Kit Number}} - \text{H or HSP}$

Individual Sets

Ford Oval use
Part Prefix
11-56xxx-H to order



Ford V8 use
Part Prefix
24-56xxx to order



Flames use
Part Prefix
17-56xxx to order



Skulls use
Part Prefix
14-56xxx to order



Ford Mustang use
Part Prefix
25-56xxx to order



We also carry these other selected Custom Emblems to choose from

Description

Part #

| | |
|--|----------|
| Bed Bolt Set 1953 to 1956 F-100..... | 11-56252 |
| Exhaust Manifold 289 and 302..... | 11-56248 |
| Fuel Pump 289 and 302..... | 11-56240 |
| Fuel Pump 351 Cleveland and 400..... | 11-56243 |
| Header Bolts..... | 11-56223 |
| Intake Manifold 429..... | 11-56246 |
| Intake Manifold FE Engine..... | 11-56245 |
| Intake Manifold 289..... | 11-56221 |
| Intake Manifold 351 Cleveland..... | 11-56222 |
| Mustang Front End Kit..... | 11-56260 |
| Rack Bolts 5/8 x 4" Grade 8 Chrome Plated..... | 11-56261 |
| Oil Pan 289 and 302..... | 11-56231 |
| Oil Pan 351 Cleveland and 400..... | 11-56232 |
| Oil Pan 390 and 428..... | 11-56233 |
| Timing Cover 289 and 302..... | 11-56242 |
| Timing Cover 390..... | 11-56244 |
| Transmission Pan Cover C4..... | 11-56235 |
| Transmission Pan Cover C6..... | 11-56234 |
| Valve Cover Aluminum 289 and 302..... | 11-56227 |
| Valve Cover Aluminum 351 Cleveland..... | 11-56228 |
| Valve Cover Steel 289..... | 11-56224 |
| Valve Cover Steel 351 Cleveland..... | 11-56225 |
| Valve Cover Steel 428..... | 11-56226 |
| Water Neck..... | 11-56230 |



Intake Manifold Kit for 429 Engine Part # 11-56246-H





Individual Sets for Mopar

Pick your style of fastener



H= Hex Caps Chrome Plated S= Allen Screws Chrome Plated B= Button Head Chrome Plated N= 12 Point Chrome Plated P= Allen Screws Polished Chrome Plated HS= Hex Bolts Stainless Steel SS= Allen Screws Stainless Steel SB= Button Head Stainless Steel HSP= Hex Bolts Stainless Steel Polished SSP= Allen Screws Stainless Steel Polished SBP= Button Head Stainless Steel Polished

| Description | Part # |
|----------------------------------|--------|
| Oil Pan Small Block..... | 56301 |
| Intake Manifold Small Block..... | 56302 |
| Header Bolts Small Block..... | 56303 |
| Valve Cover Small Block..... | 56304 |
| Water Pump Small Block..... | 56305 |
| Fuel Pump Small Block..... | 56306 |

| Description | Part # |
|--------------------------------|--------|
| Oil Pan Big Block..... | 56307 |
| Intake Manifold Big Block..... | 56308 |
| Header Bolts Big Block..... | 56309 |
| Valve Cover Big Block..... | 56310 |
| Water Pump Big Block..... | 56311 |
| Fuel Pump Big Block..... | 56312 |

You can also order the listed Individual Sets with the Emblems Stamped on the Hex Caps as shown below by using the Part Prefix associated with that emblem.

Mopar

Chrysler Pentastar use Part Prefix
21-56xxx to order



Dodge Ram use Part Prefix
22-56xxx to order



Mopar use Part Prefix
23-56xxx to order



Hemi Mopar use Part Prefix
27-56xxx to order



OFFICIAL LICENSED PRODUCT

MOPAR, JEEP, DODGE, HEMI, PLYMOUTH, RAM, SRT, CHRYSLER and related logos, vehicle model names and trade dress are trademarks of Chrysler Group LLC and used under license by (licensee name). ©2015 Chrysler Group LLC

Select style when ordering:

H = Chrome Plated or HSP = Stainless Steel Polished.

Example:

Engine Dress Up Kit Part # 21-56301- **H** or **HSP**

| Description | Part # |
|----------------------------------|----------|
| Oil Pan Small Block..... | 21-56301 |
| Intake Manifold Small Block..... | 21-56302 |
| Header Bolts Small Block..... | 21-56303 |
| Valve Cover Small Block..... | 21-56304 |
| Water Pump Small Block..... | 21-56305 |
| Fuel Pump Small Block..... | 21-56306 |

| Description | Part # |
|--------------------------------|----------|
| Oil Pan Big Block..... | 21-56307 |
| Intake Manifold Big Block..... | 21-56308 |
| Header Bolts Big Block..... | 21-56309 |
| Valve Cover Big Block..... | 21-56310 |
| Water Pump Big Block..... | 21-56311 |
| Fuel Pump Big Block..... | 21-56312 |

Buick

| Description | Part # |
|--------------------------------------|--------|
| Intake Manifold V6, 1977 - 1981..... | 56420 |
| Water Pump V6, 1977 - 1981..... | 56422 |
| Crank Pulley V6, 1977 - 1981..... | 56423 |
| Valve Cover V6..... | 56424 |

VW

| Description | Part # |
|--|---------|
| Transmission Axle Swing Acorn Kit, (Metric Thread)..... | 56800-A |
| Transmission Axle IRS Acorn Kit, (Metric Thread)..... | 56801-A |

Interior Screw Kits



Sheet Metal Screw

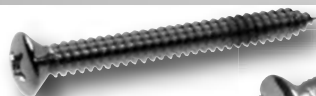

Slotted Machine Screw



Phillips Machine Screw



Interior Screw Kit Part # 57902-C



- C= Chrome Plated
- S= Stainless Steel
- SP= Stainless Steel Polished

Kits include sheet metal screws and/or machine screws. Washers are supplied where applicable.

Individual Sets

| Make | Model | Styles Available | Part # |
|---------------------|---|------------------|----------|
| Chevrolet | | | |
| 1937 - 1941 | Four Door | C S SP | 57900 |
| 1937 - 1941 | Coupe | C S SP | 57901 |
| 1937 - 1941 | Two Door Sedan | C S SP | 57902 |
| 1956 - 1957 | Two Door Sedan | C S SP | 57939 |
| | Latch Striker Dovetail Kit Two Doors | C S SP | 57001 |
| | Latch Striker Dovetail Kits thru 1958 | -- S SP | 56904 |
| Buick | | | |
| 1940 | Limited Four Door with Side Mounts | C S SP | 57400 |
| Oldsmobile | | | |
| 1947 | Four Door 78 Series | C S SP | 57501 |
| Plymouth | | | |
| 1941 | Four Door | C S SP | 57605 |
| 1946 | Two Door Sedan | C S SP | 57602 |
| Dodge | | | |
| 1933 | Coupe with Rumble Seat | C S SP | 57500 |
| 1939 | Two Door Sedan | C S SP | 57603 |
| 1939 | Two Door Coupe | C S SP | 57604 |
| Door Screws | | | |
| | Latch and Dovetail 1/4-20 x 1/2 #12 Head Stainless Steel | -- S SP | 89206-12 |
| | Latch and Dovetail 1/4-20 x 1/2 #12 Head Chrome Plated | C -- ---- | 40206-12 |
| | Striker Mounting Screws 1/4-20 x 1 #10 Head Stainless Steel | -- S SP | 94214-10 |
| | Striker Mounting Screws 1/4-20 x 1 #10 Head Chrome Plated | C -- ---- | 39214-10 |
| Hinge Screws | | | |
| 5/16-24 | x 3/4 Hex Head 9/16 across the flats Stainless Steel | -- S SP | 88275 |
| 5/16-24 | x 1 Flat Phillips Hinge Screw Stainless Steel | -- S SP | 94281 |
| 5/16-24 | x 1 Flat Phillips Hinge Chrome Plated | C -- ---- | 39281 |
| 5/16-24 | x 1 Oval Phillips Hinge Screw Stainless Steel | -- S SP | 89281 |
| 5/16-24 | x 1 Oval Phillips Hinge Screw Chrome Plated | C -- ---- | 40281 |
| 5/16 | External Countersunk Washers Stainless Steel | -- S ---- | 89570 |
| 5/16 | External Countersunk Washers Chrome Plated | C -- ---- | 35570 |



Interior Screw Kits

**Kits include sheet metal screws and/or machine screws.
Washers are supplied where applicable.**

| Ford (Stainless Steel Only) | Part # |
|-------------------------------------|---------------|
| 1928 - 1929 Coupe..... | J-286 |
| 1928 - 1929 Two Door..... | J-287 |
| 1930 - 1931 Coupe..... | J-308 |
| 1930 - 1931 Two Door..... | J-309 |
| 1932 Phaeton..... | J-321 |
| 1932 Coupe 3 Window..... | J-322 |
| 1932 Coupe 5 Window..... | J-323 |
| 1932 Coupe Two Door..... | J-324 |
| 1933 - 1934 Roadster..... | J-330 |
| 1933 - 1934 Coupe..... | J-332 |
| 1935 - 1936 Coupe..... | J-352 |
| 1936 Two Door..... | J-353 |
| 1937 Coupe..... | J-371 |
| 1937 Two Door..... | J-372 |
| 1938 - 1939 Coupe..... | J-380 |
| 1938 - 1939 Two Door..... | J-381 |
| 1938 - 1939 Convertible..... | J-383 |
| 1940 Coupe..... | J-400 |
| 1940 Two Door..... | J-401 |
| 1941 Coupe..... | J-410 |
| 1941 Two Door..... | J-411 |
| 1941 Convertible..... | J-413 |
| 1942 - 1948 Two Door and Coupe..... | J-420 |
| 1942 - 1948 Convertible..... | J-422 |

Interior Screw Kit
Part # J-401



| Hinge Screws (Chrome Plated Only) | Part # |
|--|---------------|
| 1928 - 1934 5/16-24 x 1 sold each..... | 59281 |
| 1928 - 1934 5/16-24 x 3 sold each..... | 59299 |
| 5/16 Recessed Washers..... | 23549 |

| Hinge Pins (Chrome Plated Only) | Part # |
|--|---------------|
| 1928 - 1931 Closed Car..... | 59028 |
| 1931 Slant Windshield..... | 59029 |
| 1928 - 1931 Roadster/Phaeton..... | 59030 |
| 1932 - 1948 V-8..... | 59031 |

| Hinge Pins (Stainless Steel Polished Only) | Part # |
|---|---------------|
| 10/32 x 1/2 Screw no slot..... | 59034 |
| 5/16 - 24 Cage Nuts..... | 59035 |

| Assortments | Part # |
|---|---------------|
| Interior & Door Screws in Stainless Steel..... | 56900 |
| Interior & Door Screws in Stainless Steel Polished..... | 56901 |
| Interior & Door Screws in Chrome Plated..... | 56902 |



Cage Nuts
Part # 59035



Hinge Screws
Chrome Plated
Part # 59281

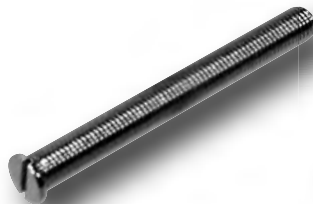

Hinge Screws
Chrome Plated
Part # 59299



Hinge Pins
Chrome Plated
Part # 59031



Hinge Pins
Chrome Plated
Part # 59030



Inside This Section

American Thread Chrome Plated

| | |
|--|-------|
| Allen Screws..... | 24 |
| Button Head Screws..... | 24 |
| Flat Head Allen Screws..... | 25 |
| 12 Point Screws..... | 25 |
| Hex Cap Screws..... | 26 |
| Torx Button Head Screws..... | 26 |
| Chevy Bowtie Hex Caps..... | 27 |
| Carriage, Body, Sems, Spinloc & Step..... | 28 |
| Ford Oval Hex Caps..... | 29 |
| Machine Screws..... | 30 |
| Washers..... | 31-32 |
| Nuts..... | 33 |
| Acorn Nuts, Covers & 12 Pt. Nuts..... | 34 |
| Spacers..... | 34 |
| Cotter Pins, Hole Plugs, Pipe Plugs, Flange, Wing Nuts..... | 35 |

American Stainless Steel

| | |
|-----------------------------|-------|
| Clamps..... | 36 |
| Chevy Bowtie Hex Caps..... | 37 |
| Ford Oval Hex Caps..... | 38 |
| Allen Screws..... | 39 |
| Button Head Screws..... | 39 |
| Flat Head Allen Screws..... | 39 |
| Hex Caps Screws..... | 40 |
| Set Screws..... | 40 |
| Washers..... | 41-42 |
| Nuts..... | 42-43 |
| Machine Screws..... | 44 |

American Zinc Plated

| | |
|---|----|
| Hex Caps (Grade 5, 8 and L-9 Products)..... | 45 |
| Allen Screws (Grade 8)..... | 45 |
| Washers and L-9 Products..... | 46 |
| Nuts and L-9 Products..... | 46 |
| Machine Screws..... | 47 |

**Bulk Fasteners
Chrome Plated
Stainless and Zinc**





Bulk Chrome Fasteners American

Allen Screws Chrome Plated and Polished Chrome



12xxx
for Chrome Allen
with Knurls



10xxx
for Polished Chrome Allen
with Knurls Removed

| | 4/40 | 6/32 | 8/32 | 10/24 | 10/32 | 1/4 -20 | 1/4 -28 | 5/16 -18 | 5/16 -24 | 3/8 -16 | 3/8 -24 | 7/16 -14 | 7/16 -20 | 1/2 -13 | 1/2 -20 | 5/8 -11 | 5/8 -18 |
|-------|-------|-------|-------|-------|-------|------------|------------|-------------|-------------|------------|------------|-------------|-------------|------------|------------|------------|------------|
| 3/8 | 12088 | 12104 | 12128 | 12152 | 12153 | 12204 | 12205 | 12268 | 12269 | | | | | | | | |
| 1/2 | 12089 | 12106 | 12130 | 12154 | 12155 | 12206 | 12207 | 12270 | 12271 | 12322 | 12323 | | | | | | |
| 5/8 | 12090 | 12108 | 12132 | 12156 | 12157 | 12208 | 12209 | 12272 | 12273 | 12324 | 12325 | | | | | | |
| 3/4 | 12091 | 12110 | 12134 | 12158 | 12159 | 12210 | 12211 | 12274 | 12275 | 12326 | 12327 | 12374 | 12375 | 12414 | 12415 | | |
| 7/8 | | 12112 | 12136 | 12160 | 12161 | 12212 | 12213 | 12278 | 12279 | 12328 | 12329 | | | | | | |
| 1 | | 12114 | 12138 | 12162 | 12163 | 12214 | 12215 | 12280 | 12281 | 12330 | 12331 | 12376 | 12377 | 12416 | 12417 | 12488 | 12489 |
| 1 1/4 | | | 12140 | 12166 | 12167 | 12218 | 12219 | 12284 | 12285 | 12334 | 12335 | 12378 | 12379 | 12418 | 12419 | 12490 | |
| 1 1/2 | | | 12142 | 12168 | 12169 | 12220 | 12221 | 12286 | 12287 | 12336 | 12337 | 12380 | 12381 | 12420 | 12421 | 12492 | 12493 |
| 1 3/4 | | | | 12170 | 12171 | 12222 | 12223 | 12288 | 12289 | 12338 | 12339 | 12382 | 12383 | 12422 | 12423 | 12494 | 12495 |
| 2 | | | | 12172 | 12173 | 12224 | 12225 | 12290 | 12291 | 12340 | 12341 | 12384 | 12385 | 12424 | 12425 | 12496 | 12497 |
| 2 1/4 | | | | 12174 | 12175 | 12226 | 12227 | 12292 | 12293 | 12342 | 12343 | 12386 | 12387 | 12426 | 12427 | 12498 | 12499 |
| 2 1/2 | | | | 12176 | 12177 | 12228 | 12229 | 12294 | 12295 | 12344 | 12345 | 12388 | 12389 | 12428 | 12429 | 12500 | 12501 |
| 2 3/4 | | | | | 12179 | 12230 | 12231 | 12296 | 12297 | 12346 | 12347 | 12390 | 12391 | 12430 | 12431 | 12502 | |
| 3 | | | | | | 12232 | 12233 | 12298 | 12299 | 12348 | 12349 | 12392 | 12393 | 12432 | 12433 | 12504 | 12505 |
| 3 1/4 | | | | | | 12234 | 12235 | 12300 | 12301 | 12350 | 12351 | 12394 | 12395 | 12434 | 12435 | 12506 | |
| 3 1/2 | | | | | | 12236 | 12237 | 12302 | 12303 | 12352 | 12353 | 12396 | 12397 | 12436 | 12437 | 12508 | 12509 |
| 4 | | | | | | 12240 | 12241 | 12306 | 12307 | 12356 | 12357 | 12400 | | 12440 | 12441 | 12512 | 12513 |
| 4 1/2 | | | | | | 12244 | | 12310 | 12311 | 12360 | 12361 | 12404 | | 12442 | 12443 | 12514 | |
| 5 | | | | | | 12246 | | 12312 | 12313 | 12362 | 12363 | 12406 | | 12444 | 12445 | 12516 | 12517 |
| 5 1/2 | | | | | | | | 12316 | 12317 | 12366 | 12367 | 12410 | | 12446 | 12447 | 12518 | 12519 |
| 6 | | | | | | 12248 | | | 12319 | 12368 | | 12412 | | 12448 | | 12520 | |

Button Head Allen Screws Chrome Plated

Button Head Allen



| | 4/40 | 6/32 | 8/32 | 10/24 | 10/32 | 12/24 | 1/4 -20 | 1/4 -28 | 5/16 -18 | 5/16 -24 | 3/8 -16 | 3/8 -24 | 7/16 -14 | 7/16 -20 | 1/2 -13 | 1/2 -20 | 5/8 -11 |
|-------|-------|-------|-------|-------|-------|-------|------------|------------|-------------|-------------|------------|------------|-------------|-------------|------------|------------|------------|
| 1/4 | 13087 | 13102 | 13126 | 13150 | 13151 | | | | | | | | | | | | |
| 3/8 | 13088 | 13104 | 13128 | 13152 | 13153 | | 13204 | 13205 | 13268 | 13269 | | | | | | | 13415 |
| 1/2 | 13089 | 13106 | 13130 | 13154 | 13155 | 13186 | 13206 | 13207 | 13270 | 13271 | 13322 | 13323 | | | | | |
| 5/8 | 13090 | 13108 | 13132 | 13156 | 13157 | | 13208 | 13209 | 13272 | 13273 | 13324 | | | | | | |
| 3/4 | 13091 | 13110 | 13134 | 13158 | 13159 | | 13210 | 13211 | 13274 | 13275 | 13326 | 13327 | | | 13414 | | |
| 7/8 | | | 13136 | 13160 | 13161 | | 13212 | 13213 | 13278 | 13279 | 13328 | | | | | | |
| 1 | | 13114 | 13138 | 13162 | 13163 | 13194 | 13214 | 13215 | 13280 | 13281 | 13330 | 13331 | 13376 | | 13416 | 13417 | 13488 |
| 1 1/4 | | | 13140 | 13166 | 13167 | | 13218 | 13219 | 13284 | 13285 | 13334 | 13335 | 13378 | 13379 | 13418 | 13419 | 13490 |
| 1 1/2 | | | | 13168 | 13169 | | 13220 | 13221 | 13286 | 13287 | 13336 | 13337 | 13380 | 13381 | 13420 | 13421 | 13492 |
| 1 3/4 | | | | | | | 13222 | 13223 | 13288 | 13289 | 13338 | 13339 | 13382 | | 13422 | | |
| 2 | | | | | | | 13224 | 13225 | 13290 | 13291 | 13340 | 13341 | 13384 | 13385 | 13424 | 13425 | 13496 |
| 2 1/4 | | | | | | | 13226 | | 13292 | | 13342 | 13343 | | | | | |
| 2 1/2 | | | | | | | 13228 | | 13294 | | 13344 | 13345 | | 13389 | 13428 | 13429 | 13500 |
| 2 3/4 | | | | | | | | | 13296 | | 13346 | | | | | | |
| 3 | | | | | | | 13232 | | 13298 | | 13348 | 13349 | | | 13432 | 13433 | 13504 |
| 3 1/2 | | | | | | | 13236 | | | | 13352 | | | | | | 13508 |
| 4 | | | | | | | 13240 | | | | 13356 | | 13400 | | 13440 | 13441 | |

Bulk Chrome Fasteners American



25

Flat Head Allen Screws Chrome Plated

Flat Head Allen



**American
Bulk Chrome**

| | 6/32 | 8/32 | 10/24 | 10/32 | 12/24 | 1/4 -20 | 1/4 -28 | 5/16 -18 | 5/16 -24 | 3/8 -16 | 3/8 -24 | 7/16 -14 | 1/2 -13 | 1/2 -20 |
|-------|-------|-------|-------|-------|-------|------------|------------|-------------|-------------|------------|------------|-------------|------------|------------|
| 1/4 | 14102 | | | | | | | | | | | | | |
| 3/8 | 14104 | 14128 | 14152 | 14153 | | 14204 | 14205 | | | | | | | |
| 1/2 | 14106 | 14130 | 14154 | 14155 | 14186 | 14206 | 14207 | 14270 | 14271 | 14322 | | | | |
| 5/8 | 14108 | 14132 | 14156 | 14157 | | 14208 | 14209 | 14272 | 14273 | 14324 | 14325 | | | |
| 3/4 | 14110 | 14134 | 14158 | 14159 | 14190 | 14210 | 14211 | 14274 | 14275 | 14326 | 14327 | 14374 | 14414 | 14527 |
| 7/8 | | 14136 | 14160 | 14161 | | 14212 | 14213 | 14278 | 14279 | 14328 | | | | |
| 1 | 14114 | 14138 | 14162 | 14163 | 14194 | 14214 | 14215 | 14280 | 14281 | 14330 | 14331 | 14376 | 14416 | 14417 |
| 1 1/4 | | 14140 | 14166 | 14167 | | 14218 | 14219 | 14284 | 14285 | 14334 | 14335 | 14378 | 14418 | 14419 |
| 1 1/2 | | 14142 | 14168 | 14169 | | 14220 | 14221 | 14286 | 14287 | 14336 | 14337 | 14380 | 14420 | 14421 |
| 1 3/4 | | | 14170 | | | 14222 | | 14288 | | 14338 | | 14382 | 14422 | 14423 |
| 2 | | | | | | 14224 | | 14290 | | 14340 | | 14384 | 14424 | 14425 |
| 2 1/4 | | | | | | | | 14292 | | 14342 | | 14386 | 14426 | |
| 2 1/2 | | | | | | 14228 | | 14294 | | 14344 | | 14388 | 14428 | |
| 2 3/4 | | | | | | 14230 | | | | 14346 | | | | |
| 3 | | | | | | 14232 | | 14302 | | 14348 | | 14392 | 14432 | |
| 3 1/2 | | | | | | 14236 | | | | 14352 | | 14396 | 14436 | |
| 4 | | | | | | 14240 | | 14306 | | | | | 14440 | |
| 4 1/2 | | | | | | | | | | 14360 | | | | |

12 Point Screws Chrome Plated

12 Point Screw



| | 1/4 -20 | 1/4 -28 | 5/16 -18 | 5/16 -24 | 3/8 -16 | 3/8 -24 | 7/16 -14 | 7/16 -20 | 1/2 -13 | 1/2 -20 | 5/8 -11 | 5/8 -18 |
|-------|------------|------------|-------------|-------------|------------|------------|-------------|-------------|------------|------------|------------|------------|
| 3/8 | | | | | | | | | | | | |
| 1/2 | 29206 | 29207 | 29270 | 29271 | 29322 | 29323 | | | | | | |
| 5/8 | 29208 | 29209 | 29272 | 29273 | | | | | | | | |
| 3/4 | 29210 | 29211 | 29274 | 29275 | 29326 | 29327 | 29374 | | 29414 | 29527 | | |
| 7/8 | 29212 | 29213 | | | | | | | | | | |
| 1 | 29214 | 29215 | 29280 | 29281 | 29330 | 29331 | 29376 | 29377 | 29416 | 29417 | 29488 | 29489 |
| 1 1/4 | 29218 | 29219 | 29284 | 29285 | 29334 | 29335 | 29378 | 29379 | 29418 | 29419 | 29490 | 29491 |
| 1 1/2 | 29220 | 29221 | 29286 | 29287 | 29336 | 29337 | 29380 | 29381 | 29420 | 29421 | 29492 | 29493 |
| 1 3/4 | 29222 | 29223 | 29288 | 29289 | 29338 | 29339 | 29382 | 29383 | 29422 | 29423 | 29494 | 29495 |
| 2 | 29224 | 29225 | 29290 | 29291 | 29340 | 29341 | 29384 | 29385 | 29424 | 29425 | 29496 | 29497 |
| 2 1/4 | 29226 | 29227 | 29292 | 29293 | 29342 | 29343 | 29386 | 29387 | 29426 | 29427 | 29498 | |
| 2 1/2 | 29228 | 29229 | 29294 | 29295 | 29344 | 29345 | 29388 | 29389 | 29428 | 29429 | 29500 | 29501 |
| 2 3/4 | 29230 | 29231 | 29296 | 29297 | 29346 | 29347 | 29390 | 29391 | 29430 | | 29502 | |
| 3 | 29232 | 29233 | 29298 | 29299 | 29348 | 29349 | 29392 | 29393 | 29432 | 29433 | 29504 | 29505 |
| 3 1/4 | | | 29300 | 29301 | 29350 | 29351 | 29394 | | 29434 | | | |
| 3 1/2 | | | 29302 | 29303 | 29352 | 29353 | 29396 | 29397 | 29436 | 29437 | 29508 | 29509 |
| 4 | | | | | 29356 | 29357 | 29400 | | 29440 | | 29512 | |
| 4 1/2 | | | | | 29360 | | | | 29442 | | 29514 | |
| 5 | | | | | 29362 | | | | 29444 | | 29516 | |



Bulk Chrome Fasteners American

Hex Caps Screws Chrome Plated Grade 5 & Grade 8

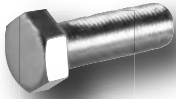

11xxx
for Grade 5
Chrome Hex Caps

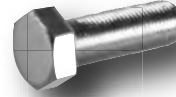

31xxx
for Grade 8
Chrome Hex Caps

| | 1/4 -20 | 1/4 -28 | 5/16 -18 | 5/16 -24 | 3/8 -16 | 3/8 -24 | 7/16 -14 | 7/16 -20 | 1/2 -13 | 1/2 -20 | 9/16 -12 | 9/16 -18 | 5/8 -11 | 5/8 -18 |
|-------|------------|------------|-------------|-------------|------------|------------|-------------|-------------|------------|------------|-------------|-------------|------------|------------|
| 1/2 | 11206 | 11207 | 11270 | 11271 | 11322 | 11323 | | | | | | | | |
| 5/8 | 11208 | 11209 | 11272 | 11273 | 11324 | 11325 | | | | | | | | |
| 3/4 | 11210 | 11211 | 11274 | 11275 | 11326 | 11327 | 11374 | 11375 | 11414 | 11527 | | | | |
| 7/8 | 11212 | 11213 | 11278 | 11279 | 11328 | 11329 | | | | | | | | |
| 1 | 11214 | 11215 | 11280 | 11281 | 11330 | 11331 | 11376 | 11377 | 11416 | 11417 | 11452 | 11453 | 11488 | 11489 |
| 1 1/4 | 11218 | 11219 | 11284 | 11285 | 11334 | 11335 | 11378 | 11379 | 11418 | 11419 | 11454 | 11455 | 11490 | 11491 |
| 1 1/2 | 11220 | 11221 | 11286 | 11287 | 11336 | 11337 | 11380 | 11381 | 11420 | 11421 | 11456 | 11457 | 11492 | 11493 |
| 1 3/4 | 11222 | 11223 | 11288 | 11289 | 11338 | 11339 | 11382 | 11383 | 11422 | 11423 | 11458 | 11459 | 11494 | 11495 |
| 2 | 11224 | 11225 | 11290 | 11291 | 11340 | 11341 | 11384 | 11385 | 11424 | 11425 | 11460 | 11461 | 11496 | 11497 |
| 2 1/4 | 11226 | 11227 | 11292 | 11293 | 11342 | 11343 | 11386 | 11387 | 11426 | 11427 | 11462 | 11463 | 11498 | 11499 |
| 2 1/2 | 11228 | 11229 | 11294 | 11295 | 11344 | 11345 | 11388 | 11389 | 11428 | 11429 | 11464 | 11465 | 11500 | 11501 |
| 2 3/4 | 11230 | 11231 | 11296 | 11297 | 11346 | 11347 | 11390 | 11391 | 11430 | 11431 | 11466 | 11467 | 11502 | 11503 |
| 3 | 11232 | 11233 | 11298 | 11299 | 11348 | 11349 | 11392 | 11393 | 11432 | 11433 | 11468 | 11469 | 11504 | 11505 |
| 3 1/4 | 11234 | 11235 | 11300 | 11301 | 11350 | 11351 | 11394 | 11395 | 11434 | 11435 | 11470 | 11471 | 11506 | 11507 |
| 3 1/2 | 11236 | 11237 | 11302 | 11303 | 11352 | 11353 | 11396 | 11397 | 11436 | 11437 | 11472 | 11473 | 11508 | 11509 |
| 4 | 11240 | 11241 | 11306 | 11307 | 11356 | 11357 | 11400 | 11401 | 11440 | 11441 | 11476 | 11477 | 11512 | 11513 |
| 4 1/2 | 11244 | | 11310 | 11311 | 11360 | 11361 | 11404 | 11405 | 11442 | 11443 | 11478 | 11479 | 11514 | 11515 |
| 5 | 11246 | | 11312 | 11313 | 11362 | 11363 | 11406 | 11407 | 11444 | 11445 | 11480 | 11481 | 11516 | 11517 |
| 5 1/2 | 11246-B | 11247-C | 11316 | 11317 | 11366 | 11367 | 11410 | 11411 | 11446 | 11447 | 11482 | 11483 | 11518 | 11519 |
| 6 | 11246-A | 11247-A | 11318 | 11319 | 11368 | 11369 | 11412 | | 11448 | 11449 | 11484 | 11485 | 11520 | 11521 |

Torx Button Head Screws Chrome Plated

Torx Button Head

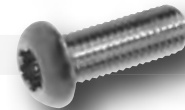

| | 8/32 | 10/24 | 10/32 | 1/4 -20 | 1/4 -28 | 5/16 -18 | 5/16 -24 | 3/8 -16 | 3/8 -24 | 1/2 -13 |
|-------|-------|-------|-------|------------|------------|-------------|-------------|------------|------------|------------|
| 1/4 | 46126 | 46150 | 46151 | | | | | | | |
| 3/8 | 46128 | 46152 | 46153 | 46204 | 46205 | 46268 | 46269 | | | |
| 1/2 | 46130 | 46154 | 46155 | 46206 | 46207 | 46270 | 46271 | 46322 | 46323 | |
| 5/8 | 46132 | 46156 | 46157 | 46208 | 46209 | 46272 | 46273 | 46324 | | |
| 3/4 | 46134 | 46158 | 46159 | 46210 | 46211 | 46274 | 46275 | 46326 | | |
| 7/8 | | 46160 | 46160 | 46212 | | 46278 | | 46328 | | |
| 1 | | 46162 | 46163 | 46214 | 46215 | 46280 | 46281 | 46330 | 46331 | 46416 |
| 1 1/4 | | | | 46218 | | | | 46334 | | 46418 |
| 1 1/2 | | | | 46220 | | | | 46336 | | 46420 |
| 1 3/4 | | | | 46222 | | | | 46338 | | |
| 2 | | | | 46224 | | | | 46340 | | |
| 2 1/4 | | | | 46226 | | | | 46342 | | |
| 2 1/2 | | | | 46228 | | | | 46344 | | |
| 2 3/4 | | | | | | | | 46346 | | |
| 3 | | | | 46232 | | | | 46348 | | |

Bulk Chrome Fasteners American



27

Screws

Bowtie Hex Cap



Bowtie Hex Caps

| | 1/4 -20 | 1/4 -28 | 5/16 -18 | 5/16 -24 | 3/8 -16 | 3/8 -24 | 7/16 -14 | 7/16 -20 | 1/2 -13 | 1/2 -20 | 9/16 -12 | 9/16 -18 | 5/8 -11 | 5/8 -18 |
|-------|------------|------------|-------------|-------------|------------|------------|-------------|-------------|------------|------------|-------------|-------------|------------|------------|
| 1/2 | 10-11206 | 10-11207 | 10-11270 | 10-11271 | 10-11322 | 10-11323 | | | | | | | | |
| 5/8 | 10-11208 | 10-11209 | 10-11272 | 10-11273 | 10-11324 | 10-11325 | | | | | | | | |
| 3/4 | 10-11210 | 10-11211 | 10-11274 | 10-11275 | 10-11326 | 10-11327 | 10-11374 | 10-11375 | 10-11414 | 10-11527 | | | | |
| 7/8 | 10-11212 | 10-11213 | 10-11278 | 10-11279 | 10-11328 | 10-11329 | | | | | | | | |
| 1 | 10-11214 | 10-11215 | 10-11280 | 10-11281 | 10-11330 | 10-11331 | 10-11376 | 10-11377 | 10-11416 | 10-11417 | 10-11452 | 10-11453 | 10-11488 | 10-11489 |
| 1 1/4 | 10-11218 | 10-11219 | 10-11284 | 10-11285 | 10-11334 | 10-11335 | 10-11378 | 10-11379 | 10-11418 | 10-11419 | 10-11454 | 10-11455 | 10-11490 | 10-11491 |
| 1 1/2 | 10-11220 | 10-11221 | 10-11286 | 10-11287 | 10-11336 | 10-11337 | 10-11380 | 10-11381 | 10-11420 | 10-11421 | 10-11456 | 10-11457 | 10-11492 | 10-11493 |
| 1 3/4 | 10-11222 | 10-11223 | 10-11288 | 10-11289 | 10-11338 | 10-11339 | 10-11382 | 10-11383 | 10-11422 | 10-11423 | 10-11458 | 10-11459 | 10-11494 | 10-11495 |
| 2 | 10-11224 | 10-11225 | 10-11290 | 10-11291 | 10-11340 | 10-11341 | 10-11384 | 10-11385 | 10-11424 | 10-11425 | 10-11460 | 10-11461 | 10-11496 | 10-11497 |
| 2 1/4 | 10-11226 | 10-11227 | 10-11292 | 10-11293 | 10-11342 | 10-11343 | 10-11386 | 10-11387 | 10-11426 | 10-11427 | 10-11462 | 10-11463 | 10-11498 | 10-11499 |
| 2 1/2 | 10-11228 | 10-11229 | 10-11294 | 10-11295 | 10-11344 | 10-11345 | 10-11388 | 10-11389 | 10-11428 | 10-11429 | 10-11464 | 10-11465 | 10-11500 | 10-11501 |
| 2 3/4 | 10-11230 | 10-11231 | 10-11296 | 10-11297 | 10-11346 | 10-11347 | 10-11390 | 10-11391 | 10-11430 | 10-11431 | 10-11466 | 10-11467 | 10-11502 | 10-11503 |
| 3 | 10-11232 | 10-11233 | 10-11298 | 10-11299 | 10-11348 | 10-11349 | 10-11392 | 10-11393 | 10-11432 | 10-11433 | 10-11468 | 10-11469 | 10-11504 | 10-11505 |
| 3 1/4 | 10-11234 | 10-11235 | 10-11300 | 10-11301 | 10-11350 | 10-11351 | 10-11394 | 10-11395 | 10-11434 | 10-11435 | 10-11470 | 10-11471 | 10-11506 | 10-11507 |
| 3 1/2 | 10-11236 | 10-11237 | 10-11302 | 10-11303 | 10-11352 | 10-11353 | 10-11396 | 10-11397 | 10-11436 | 10-11437 | 10-11472 | 10-11473 | 10-11508 | 10-11509 |
| 4 | 10-11240 | 10-11241 | 10-11306 | 10-11307 | 10-11356 | 10-11357 | 10-11400 | 10-11401 | 10-11440 | 10-11441 | 10-11476 | 10-11477 | 10-11512 | 10-11513 |
| 4 1/2 | 10-11244 | | 10-11310 | 10-11311 | 10-11360 | 10-11361 | 10-11404 | 10-11405 | 10-11442 | 10-11443 | 10-11478 | 10-11479 | 10-11514 | 10-11515 |
| 5 | 10-11246 | | 10-11312 | 10-11313 | 10-11362 | 10-11363 | 10-11406 | 10-11407 | 10-11445 | 10-11446 | 10-11480 | 10-11481 | 10-11516 | 10-11517 |
| 5 1/2 | 10-11246-B | 10-11247-C | 10-11316 | 10-11317 | 10-11366 | 10-11367 | 10-11410 | 10-11411 | 10-11447 | 10-11448 | 10-11482 | 10-11483 | 10-11518 | 10-11519 |
| 6 | 10-11246-A | 10-11247-A | 10-11318 | 10-11319 | 10-11368 | 10-11369 | 10-11412 | 10-11413 | 10-11449 | 10-11450 | 10-11484 | 10-11485 | 10-11520 | 10-11521 |

Bowtie Body Bolts

| Size | Part # |
|-----------------------------|-------------|
| 14 x 3/4 - 3/8 Hex | 10-55669-P3 |
| 14 x 3/4 - 7/16 Hex | 10-55669-P7 |
| 5/16 x 13/16 | 10-22276 |
| 5/16 x 1 1/4 | 10-22284 |
| Stainless Steel Only | |
| 5/16 x 13/16 | 10-88276 |



Body Bolt

Bowtie Spinloc Bolts

| Size | Part # |
|-----------------|----------|
| 1/4-20 x 5/8 | 10-43208 |
| 5/16-18 x 3/4 | 10-43274 |
| 5/16-18 x 1 | 10-43280 |
| 5/16-18 x 1 1/4 | 10-43284 |
| 5/16-24 x 1 | 10-43281 |
| 3/8-16 x 1 | 10-43330 |



Spinloc Bolt

Bowtie Hex Washer Sems Polished & Chrome Plated

| With Washer Loose From Head | | |
|-----------------------------|-------------|----------|
| Size | Washer O.D. | Part # |
| 1/4-20 x 7/8 | 3/4" | 10-25212 |
| 5/16-18 x 1 | 1" | 10-25280 |
| 3/8-16 x 3/4 | 1" | 10-25326 |
| 3/8-16 x 1 | 1" | 10-25330 |
| 3/8-16 x 1 1/2 | 1" | 10-25336 |



Hex Washer Sem



OFFICIAL LICENSED PRODUCT

Bolts Also Available In These Selected Emblem Stamped Hex Cap Styles

| | | | | |
|---|---|--|--|--|
| Chevy SS Use Part Prefix 13-xxxxx to order | Chevy RS Use Part Prefix 16-xxxxx to order | Chevy 350 Use Part Prefix 18-xxxxx to order | Chevy 454 Use Part Prefix 19-xxxxx to order | Flame Use Part Prefix 17-xxxxx to order |
| Pontiac Use Part Prefix 12-xxxxx to order | GTO Use Part Prefix 20-xxxxx to order | GT Use Part Prefix 15-xxxxx to order | Olds Rocket Use Part Prefix 26-xxxxx to order | Skull Use Part Prefix 14-xxxxx to order |



Bulk Chrome Fasteners American

Screws

Carriage Bolts

Carriage Bolt

| | 3/16 | 1/4 | 5/16 | 3/8 | 7/16 | 1/2 |
|-------|-------|-------|-------|-------|-------|-------|
| 1/2 | 27154 | 27206 | | | | |
| 3/4 | | 27210 | 27274 | 27326 | | |
| 1 | 27162 | 27214 | 27280 | 27330 | 27376 | 27416 |
| 1 1/2 | 27168 | 27220 | 27286 | 27336 | 27380 | 27420 |
| 1 3/4 | | 27222 | | | 27382 | 27422 |
| 2 | | 27224 | 27290 | 27340 | 27384 | 27424 |
| 2 1/4 | | 27226 | 27292 | | | |
| 2 1/2 | | 27228 | 27294 | 27344 | 27388 | 27428 |
| 2 3/4 | | | 27296 | | | |
| 3 | | 27232 | 27298 | 27348 | 27392 | 27432 |
| 3 1/2 | | 27236 | 27302 | 27352 | 27396 | 27436 |
| 4 | | 27240 | 27306 | 27356 | 27400 | 27440 |
| 4 1/2 | | | 27310 | 27360 | 27404 | 27442 |
| 5 | | 27246 | 27312 | 27362 | 27406 | 27444 |
| 5 1/2 | | | | | 27410 | 27446 |
| 6 | | | 27318 | 27368 | | 27448 |



Spinloc Bolts

Spinloc Bolt

| Size | Part # |
|-----------------|--------|
| 1/4-20 x 5/8 | 43208 |
| 5/16-18 x 3/4 | 43274 |
| 5/16-18 x 1 | 43280 |
| 5/16-18 x 1 1/4 | 43284 |
| 5/16-24 x 1 | 43281 |
| 3/8-16 x 1 | 43330 |



Step Bolts

Step Bolt

| Size | Part # |
|--------------|--------|
| 1/4 x 1 | 28214 |
| 1/4 x 1 1/2 | 28220 |
| 1/4 x 2 | 28224 |
| 5/16 x 1 | 28280 |
| 5/16 x 1 1/2 | 28286 |
| 5/16 x 2 1/2 | 28294 |
| 3/8 x 1 | 28330 |
| 3/8 x 1 1/2 | 28336 |



Body Bolts

Body Bolt

| Size | Part # |
|---------------------------------------|----------|
| 14 x 3/4-3/8 Hex | 55669-3 |
| 14 x 3/4-7/16 Hex | 55669-7 |
| 14 x 3/4-3/8 Hex w/ loose washer | 55669-W3 |
| 14 x 3/4-7/16 Hex w/ loose washer | 55669-W7 |
| Body Bolts with Polished Heads | |
| 14 x 3/4-3/8 Hex | 55669-P3 |
| 14 x 3/4-7/16 Hex | 55669-P7 |
| 5/16 x 13/16 | 22276 |
| 5/16 x 1 1/4 | 22284 |
| Body Bolts in Stainless Steel | |
| 5/16 x 13/16 | 88276 |
| Body Bolts Unpolished | |
| 5/16 x 13/16 | 09276 |
| 5/16 x 1 1/4 | 09284 |



Body & Spinloc Bolt Assortment
20 Sizes with 200 pieces Part # A-201

Mag Wheel Washers

| Size | O.D. is 1 1/8" | Part # |
|-------|--------------------|----------|
| 11/16 | Chrome | 23578 |
| | Stainless | 75578 |
| | Stainless Polished | SP-75578 |

Throttle Return Springs

| Size | Part # |
|----------------------------------|-------------|
| Chrome Plated Inner & Outer | 09012 |
| Chrome Outer & Gold Plated Inner | 09013 |
| Gold Plated Inner & Outer | 09015 |
| Gold Plated Outer & Chrome Inner | 09014 |
| Black | 09012-black |
| Red | 09012-red |
| White | 09012-white |
| Blue | 09012-blue |

Hex Washer Sems Polished and Chrome Plated

With washer loose from head

Hex Washer Sem

| Size | Washer O.D. | Part # |
|----------------|-------------|--------|
| 1/4-20 x 7/8 | 3/4" | 25212 |
| 5/16-18 x 1 | 1" | 25280 |
| 3/8-16 x 3/4 | 1" | 25326 |
| 3/8-16 x 1 | 1" | 25330 |
| 3/8-16 x 1 1/2 | 1 1/8" | 25336 |



Throttle Return Springs

Bulk Chrome Fasteners American



29

Screws

Ford Oval Hex Cap

Ford Oval Hex Caps

| | 1/4 -20 | 1/4 -28 | 5/16 -18 | 5/16 -24 | 3/8 -16 | 3/8 -24 | 7/16 -14 | 7/16 -20 | 1/2 -13 | 1/2 -20 | 9/16 -12 | 9/16 -18 | 5/8 -11 | 5/8 -18 |
|-------|------------|------------|-------------|-------------|------------|------------|-------------|-------------|------------|------------|-------------|-------------|------------|------------|
| 1/2 | 11-11206 | 11-11207 | 11-11270 | 11-11271 | 11-11322 | 11-11323 | | | | | | | | |
| 5/8 | 11-11208 | 11-11209 | 11-11272 | 11-11273 | 11-11324 | 11-11325 | | | | | | | | |
| 3/4 | 11-11210 | 11-11211 | 11-11274 | 11-11275 | 11-11326 | 11-11327 | 11-11374 | 11-11375 | 11-11414 | 11-11527 | | | | |
| 7/8 | 11-11212 | 11-11213 | 11-11278 | 11-11279 | 11-11328 | 11-11329 | | | | | | | | |
| 1 | 11-11214 | 11-11215 | 11-11280 | 11-11281 | 11-11330 | 11-11331 | 11-11376 | 11-11377 | 11-11416 | 11-11417 | 11-11452 | 11-11453 | 11-11488 | 11-11489 |
| 1 1/4 | 11-11218 | 11-11219 | 11-11284 | 11-11285 | 11-11334 | 11-11335 | 11-11378 | 11-11379 | 11-11418 | 11-11419 | 11-11454 | 11-11455 | 11-11490 | 11-11491 |
| 1 1/2 | 11-11220 | 11-11221 | 11-11286 | 11-11287 | 11-11336 | 11-11337 | 11-11380 | 11-11381 | 11-11420 | 11-11421 | 11-11456 | 11-11457 | 11-11492 | 11-11493 |
| 1 3/4 | 11-11222 | 11-11223 | 11-11288 | 11-11289 | 11-11338 | 11-11339 | 11-11382 | 11-11383 | 11-11422 | 11-11423 | 11-11458 | 11-11459 | 11-11494 | 11-11495 |
| 2 | 11-11224 | 11-11225 | 11-11290 | 11-11291 | 11-11340 | 11-11341 | 11-11384 | 11-11385 | 11-11424 | 11-11425 | 11-11460 | 11-11461 | 11-11496 | 11-11497 |
| 2 1/4 | 11-11226 | 11-11227 | 11-11292 | 11-11293 | 11-11342 | 11-11343 | 11-11386 | 11-11387 | 11-11426 | 11-11427 | 11-11462 | 11-11463 | 11-11498 | 11-11499 |
| 2 1/2 | 11-11228 | 11-11229 | 11-11294 | 11-11295 | 11-11344 | 11-11345 | 11-11388 | 11-11389 | 11-11428 | 11-11429 | 11-11464 | 11-11465 | 11-11500 | 11-11501 |
| 2 3/4 | 11-11230 | 11-11231 | 11-11296 | 11-11297 | 11-11346 | 11-11347 | 11-11390 | 11-11391 | 11-11430 | 11-11431 | 11-11466 | 11-11467 | 11-11502 | 11-11503 |
| 3 | 11-11232 | 11-11233 | 11-11298 | 11-11299 | 11-11348 | 11-11349 | 11-11392 | 11-11393 | 11-11432 | 11-11433 | 11-11468 | 11-11469 | 11-11504 | 11-11505 |
| 3 1/4 | 11-11234 | 11-11235 | 11-11300 | 11-11301 | 11-11350 | 11-11351 | 11-11394 | 11-11395 | 11-11434 | 11-11435 | 11-11470 | 11-11471 | 11-11506 | 11-11507 |
| 3 1/2 | 11-11236 | 11-11237 | 11-11302 | 11-11303 | 11-11352 | 11-11353 | 11-11396 | 11-11397 | 11-11436 | 11-11437 | 11-11472 | 11-11473 | 11-11508 | 11-11509 |
| 4 | 11-11240 | 11-11241 | 11-11306 | 11-11307 | 11-11356 | 11-11357 | 11-11400 | 11-11401 | 11-11440 | 11-11441 | 11-11476 | 11-11477 | 11-11512 | 11-11513 |
| 4 1/2 | 11-11244 | | 11-11310 | 11-11311 | 11-11360 | 11-11361 | 11-11404 | 11-11405 | 11-11442 | 11-11443 | 11-11478 | 11-11479 | 11-11514 | 11-11515 |
| 5 | 11-11246 | | 11-11312 | 11-11313 | 11-11362 | 11-11363 | 11-11406 | 11-11407 | 11-11445 | 11-11446 | 11-11480 | 11-11481 | 11-11516 | 11-11517 |
| 5 1/2 | 11-11246-B | 11-11247-C | 11-11316 | 11-11317 | 11-11366 | 11-11367 | 11-11410 | 11-11411 | 11-11447 | 11-11448 | 11-11482 | 11-11483 | 11-11518 | 11-11519 |
| 6 | 11-11246-A | 11-11247-A | 11-11318 | 11-11319 | 11-11368 | 11-11369 | 11-11412 | 11-11413 | 11-11449 | 11-11450 | 11-11484 | 11-11485 | 11-11520 | 11-11521 |

Ford Oval Body Bolts

| Size | Part # |
|-----------------------------|-------------|
| 1/4 x 3/4 - 3/8 Hex | 11-55669-P3 |
| 1/4 x 3/4 - 7/16 Hex | 11-55669-P7 |
| 5/16 x 13/16 | 11-22276 |
| 5/16 x 1 1/4 | 11-22284 |
| Stainless Steel Only | |
| 5/16 x 13/16 | 11-88276 |

Ford Oval Spinloc Bolts

| Size | Part # |
|-----------------|----------|
| 1/4-20 x 5/8 | 11-43208 |
| 5/16-18 x 3/4 | 11-43274 |
| 5/16-18 x 1 | 11-43280 |
| 5/16-18 x 1 1/4 | 11-43284 |
| 5/16-24 x 1 | 11-43281 |
| 3/8-16 x 1 | 11-43330 |

Ford Oval Hex Washer Sems Polished & Chrome Plated

| Size | Washer O.D. | Part # |
|----------------|-------------|----------|
| 1/4-20 x 7/8 | 3/4" | 11-25212 |
| 5/16-18 x 1 | 1" | 11-25280 |
| 3/8-16 x 3/4 | 1" | 11-25326 |
| 3/8-16 x 1 | 1" | 11-25330 |
| 3/8-16 x 1 1/2 | 1" | 11-25336 |



Body Bolt



Spinloc Bolt



Hex Washer Sem

Example: Part # 24-11210 to Purchase: 1/4-20 x 3/4 Ford V-8 Stamped Hex Cap in Chrome



Ford Oval
Use Part Prefix
11-xxxxx to order



Ford V8
Use Part Prefix
24-xxxxx to order



Ford Mustang
Use Part Prefix
25-xxxxx to order



Bulk Chrome Fasteners American

Machine and Sheet Metal Screws Chrome Plated

Example: To order a **8/32 x 5/8 Oval Phillips Machine Screw**: Use **Chart #1** for the type of head style required, take those first two digits for the beginning part number which would be **"40"**. Now look up the diameter and length from **Chart #2 or #3** for last three digits for **8/32 x 5/8** is **"132"**. Put the two together for a part number of **40132**, or simply order by style and size.

Chart #1: Select Styles

| Style | Chrome Slotted | Phillips |
|------------|----------------|----------|
| Round Head | 33xxx | 38xxx |
| Flat Head | 36xxx | 39xxx |
| Truss Head | 51xxx | 53xxx |
| Oval Head | 34xxx | 40 / 57* |
| Pan Head | 35xxx | 41xxx |
| Fillister | 37xxx | n/a |
| Hex | 55xxx | n/a |
| Round Wood | 33xxx | n/a |
| Flat Wood | 47xxx | 49xxx |
| Oval Wood | 48xxx | 50xxx |

***NOTE: Not all styles available in all sizes**

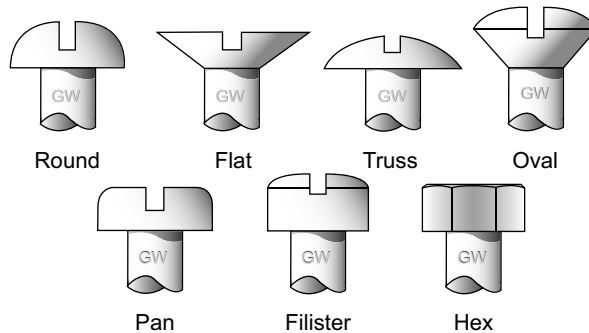

***NOTE: Oval Phillips Sheet Metal Screws use Prefix 57 not 40**

Chart #2: Machine Screw Sizes

| | 6/32 | 8/32 | 10/24 | 10/32 | 12/24 | 1/4 -20 | 1/4 -28 | 5/16 -18 | 5/16 -24 | 3/8 -16 |
|-------|------|------|-------|-------|-------|------------|------------|-------------|-------------|------------|
| 3/8 | 104 | 128 | 152 | 153 | 184 | 204 | | | | |
| 1/2 | 106 | 130 | 154 | 155 | 186 | 206 | | 270 | | |
| 5/8 | | 132 | 156 | 157 | 188 | 208 | 209 | | | |
| 3/4 | 110 | 134 | 158 | 159 | 190 | 210 | 211 | 274 | 275 | |
| 7/8 | | 136 | 160 | 161 | 192 | 212 | | | | |
| 1 | 114 | 138 | 162 | 163 | 194 | 214 | 215 | 280 | 281 | 330 |
| 1 1/4 | 116 | 140 | 166 | 167 | 196 | 218 | 219 | 284 | 285 | 334 |
| 1 1/2 | 118 | 142 | 168 | 169 | 198 | 220 | 221 | 286 | 287 | 336 |
| 1 3/4 | | | 170 | 171 | | 222 | | 288 | 289 | 338 |
| 2 | 122 | | 172 | 173 | | 224 | | 290 | 291 | 340 |



Machine Screw

Chart #3: Sheet Metal & Wood Screw Sizes

| | #6 | #8 | #10 | #12 | #14 |
|-------|-----|-----|-----|-----|-----|
| 1/2 | 616 | 628 | 641 | 654 | 667 |
| 5/8 | 617 | 629 | 642 | 655 | 668 |
| 3/4 | 618 | 630 | 643 | 656 | 669 |
| 1 | 620 | 632 | 645 | 658 | 671 |
| 1 1/4 | 621 | 633 | 646 | 659 | 672 |
| 1 1/2 | 622 | 634 | 647 | 660 | 673 |
| 1 3/4 | 623 | 680 | 648 | 661 | 674 |
| 2 | 624 | 635 | 649 | 662 | 675 |
| 2 1/4 | | | | 663 | 676 |
| 2 1/2 | | | | 664 | 677 |



Sheet Metal Screw



Woodscrew



American Bulk Chrome

Washers Chrome Plated

Flat Washers Standard SAE

| Size | Part # |
|------|--------|
| 4 | 23564 |
| 6 | 23565 |
| 8 | 23566 |
| 10 | 23567 |
| 12 | 23568 |
| 1/4 | 23569 |
| 5/16 | 23570 |
| 3/8 | 23571 |
| 7/16 | 23572 |
| 1/2 | 23573 |
| 9/16 | 23574 |
| 5/8 | 23575 |
| 3/4 | 23576 |

Flat Washer



Hardened Flat Washer "G-W" Washers

| Size | Part # |
|------|--------|
| 1/4 | 33569 |
| 5/16 | 33570 |
| 3/8 | 33571 |
| 7/16 | 33572 |
| 1/2 | 33573 |
| 5/8 | 33575 |

Hardened Flat Washer



AN Flat Washers Small OD Chrome

| Size | Part # |
|------|--------|
| 10 | 26567 |
| 1/4 | 26569 |
| 5/16 | 26570 |
| 3/8 | 26571 |
| 7/16 | 26572 |
| 1/2 | 26573 |
| 9/16 | 26574 |
| 5/8 | 26575 |
| 3/4 | 26576 |
| 1 | 26577 |

AN Flat Washer



Lock Washers

| Size | Part # |
|------|--------|
| 4 | 24564 |
| 6 | 24565 |
| 8 | 24566 |
| 10 | 24567 |
| 12 | 24568 |
| 1/4 | 24569 |
| 5/16 | 24570 |
| 3/8 | 24571 |
| 7/16 | 24572 |
| 1/2 | 24573 |
| 9/16 | 24574 |
| 5/8 | 24575 |
| 3/4 | 24576 |

Lock Washer



Also Available in Assortments

All Items shown on this page can be purchased individually

High Collar Lock Washers

| Size | Part # |
|------|--------|
| 8 | 25566 |
| 10 | 25567 |
| 1/4 | 25569 |
| 5/16 | 25570 |
| 3/8 | 25571 |
| 7/16 | 25572 |
| 1/2 | 25573 |
| 5/8 | 25575 |



Internal Lock Washers

| Size | Part # |
|------|--------|
| 6 | 29565 |
| 8 | 29566 |
| 10 | 29567 |
| 12 | 29568 |
| 1/4 | 29569 |
| 5/16 | 29570 |
| 3/8 | 29571 |
| 7/16 | 29572 |
| 1/2 | 29573 |
| 5/8 | 29575 |

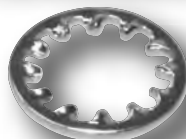

External Countersunk Washers

| Size | Part # |
|------|--------|
| 6 | 35565 |
| 8 | 35566 |
| 10 | 35567 |
| 12 | 35568 |
| 1/4 | 35569 |
| 5/16 | 35570 |



External Lock Washers

| Size | Part # |
|------|--------|
| 6 | 32565 |
| 8 | 32566 |
| 10 | 32567 |
| 12 | 32568 |
| 1/4 | 32569 |
| 5/16 | 32570 |
| 3/8 | 32571 |
| 7/16 | 32572 |
| 1/2 | 32573 |



Note: O.D. of Washer is the same as the Head of the Allen Screw

Having difficulties locating a particular item please call



Washers Chrome Plated

Cup Washers

| Size | Part # |
|--------------|--------|
| 3/8 x 1 1/4 | 22334 |
| 1/2 x 1 1/4 | 22418 |
| 1/2 x 1 7/16 | 22420 |
| 5/8 x 1 1/4 | 22490 |



22334 Cup Washer 22418 Cup Washer 22420 Cup Washer 22490 Cup Washer

Cup Washers Sold Each.

Finishing Washer

| Size | Part # |
|------|--------|
| 6 | 34565 |
| 8 | 34566 |
| 10 | 34567 |
| 12 | 34568 |
| 14 | 34569 |



Finishing Washer

Flush Washer

| Size | Part # |
|------|--------|
| 6 | 41565 |
| 8 | 41566 |
| 10 | 41567 |



Flush Washer

Flat Washer USS Standard

| Size | I.D. | O.D. | Part # |
|------|------|-------|--------|
| 1/4 | 5/16 | 3/4 | 23274 |
| 5/16 | 3/8 | 7/8 | 23328 |
| 3/8 | 7/16 | 1 | 23376 |
| 7/16 | 1/2 | 1 1/4 | 23418 |
| 1/2 | 9/16 | 1 3/8 | 23456 |
| 9/16 | 5/8 | 1 1/2 | 23492 |



Flat Washer

For
Stainless Steel
Super Flat
Fender Washers
See page 41

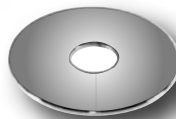

Super
Flat Washers
Sold Each.

Super Flat Fender Washers

| Size | O.D. | Thickness | Part # |
|-------|--------|-------------|--------|
| #8 | 3/4 | | 23134 |
| #10 | 3/4 | | 23158 |
| #10 | 1 | | 23162 |
| 5/16 | 5/32 | 3/64 | 23128 |
| 3/16 | 1 | | 23162 |
| 1/4 | 7/8 | | 23212 |
| 1/4 | 1 | | 23214 |
| 1/4 | 1 1/4 | | 23218 |
| 5/16 | 1 | | 23280 |
| 5/16 | 3/4 | | 23274 |
| 5/16 | 13/16 | 3/32 | 23278 |
| 5/16 | 1 1/8 | | 23282 |
| 5/16 | 1 1/4 | | 23284 |
| 5/16 | 1 1/2 | | 23286 |
| 5/16 | 1 1/2 | 1/8 | 23286H |
| 11/32 | 1 1/32 | | 23283 |
| 13/32 | 11/16 | 1/16 | 23326 |
| 3/8 | 3/4 | .060 | 23326A |
| 3/8 | 7/8 | | 23328 |
| 3/8 | | Heat Treat | 23329 |
| 3/8 | 1 1/4 | | 23334 |
| 3/8 | 1 1/2 | | 23336 |
| 3/8 | 1 1/2 | 1/8 | 23336H |
| 3/8 | 2 | 1/16 | 23340 |
| 7/16 | 29/32 | .190 | 23374 |
| 7/16 | 15/16 | | 23375 |
| 7/16 | 1 | 1/8 | 23376 |
| 7/16 | 1 1/8 | 5/32 | 23377 |
| 7/16 | 1 1/8 | | 23379 |
| 1/2 | 13/16 | | 23415 |
| 1/2 | 1 1/8 | | 23416 |
| 1/2 | 1 1/4 | | 23418 |
| 1/2 | 2 | | 23424 |
| 9/16 | 1 3/8 | | 23456 |
| 5/8 | 1 1/2 | | 23492 |
| 5/8 | 1 3/4 | | 23495 |
| 21/32 | 1 1/16 | | 23488 |
| 11/16 | 1 3/8 | 3/16 | 23496 |
| 11/16 | 1 3/8 | Pivot Shaft | 23579 |
| 7/16 | 2 | | 23594 |



Nuts Chrome Plated

Hex Nuts

| Size | Part # |
|---------|--------|
| 4/40 | 15536 |
| 5/40 | 15537 |
| 6/32 | 15538 |
| 8/32 | 15540 |
| 10/24 | 15542 |
| 10/32 | 15543 |
| 12/24 | 15544 |
| 1/4-20 | 15546 |
| 1/4-28 | 15547 |
| 5/16-18 | 15548 |
| 5/16-24 | 15549 |
| 3/8-16 | 15550 |
| 3/8-24 | 15551 |
| 7/16-14 | 15552 |
| 7/16-20 | 15553 |
| 1/2-13 | 15554 |
| 1/2-20 | 15555 |
| 9/16-12 | 15556 |
| 9/16-18 | 15557 |
| 5/8-11 | 15558 |
| 5/8-18 | 15559 |
| 3/4-10 | 15560 |
| 3/4-16 | 15561 |



Hex Nuts
1/4, 5/16 and 3/8
Sold
100 per bag.



Nylon Insert Lock Nuts

| Size | Part # |
|---------|--------|
| 4/40 | 17536 |
| 5/40 | 17537 |
| 6/32 | 17538 |
| 8/32 | 17540 |
| 10/24 | 17542 |
| 10/32 | 17543 |
| 12/24 | 17544 |
| 1/4-20 | 17546 |
| 1/4-28 | 17547 |
| 5/16-18 | 17548 |
| 5/16-24 | 17549 |
| 3/8-16 | 17550 |
| 3/8-24 | 17551 |
| 7/16-14 | 17552 |
| 7/16-20 | 17553 |
| 1/2-13 | 17554 |
| 1/2-20 | 17555 |
| 9/16-12 | 17556 |
| 9/16-18 | 17557 |
| 5/8-11 | 17558 |
| 5/8-18 | 17559 |
| 3/4-10 | 17560 |
| 3/4-16 | 17561 |

Thin Jam Lock Nuts

| Size | Part # |
|---------|--------|
| 1/4-20 | 27546 |
| 1/4-28 | 27547 |
| 5/16-18 | 27548 |
| 5/16-24 | 27549 |
| 3/8-16 | 27550 |
| 3/8-24 | 27551 |
| 7/16-14 | 27552 |
| 7/16-20 | 27553 |
| 1/2-13 | 27554 |
| 1/2-20 | 27555 |
| 9/16-12 | 27556 |
| 9/16-18 | 27557 |
| 5/8-11 | 27558 |
| 5/8-18 | 27559 |
| 3/4-10 | 27560 |
| 3/4-16 | 27561 |



Flexloc® Nuts (All Metal)

| Size | Part # |
|---------|--------|
| 10/24 | 18542 |
| 10/32 | 18543 |
| 1/4-20 | 18546 |
| 1/4-28 | 18547 |
| 5/16-18 | 18548 |
| 5/16-24 | 18549 |
| 3/8-16 | 18550 |
| 3/8-24 | 18551 |
| 7/16-14 | 18552 |
| 7/16-20 | 18553 |
| 1/2-13 | 18554 |
| 1/2-20 | 18555 |
| 9/16-12 | 18556 |
| 9/16-18 | 18557 |
| 5/8-11 | 18558 |
| 5/8-18 | 18559 |
| 3/4-10 | 18560 |
| 3/4-16 | 18561 |

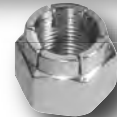

All items shown on this page can be purchased individually

American Bulk Chrome

Slotted Nuts

| Size | Part # |
|---------|--------|
| 1/4-20 | 22546 |
| 1/4-28 | 22547 |
| 5/16-18 | 22548 |
| 5/16-24 | 22549 |
| 3/8-16 | 22550 |
| 3/8-24 | 22551 |
| 7/16-14 | 22552 |
| 7/16-20 | 22553 |
| 1/2-13 | 22554 |
| 1/2-20 | 22555 |
| 9/16-12 | 22556 |
| 9/16-18 | 22557 |
| 5/8-11 | 22558 |
| 5/8-18 | 22559 |
| 3/4-10 | 22560 |
| 3/4-16 | 22561 |



Allen Nuts

| Size | Part # |
|---------|--------|
| 10/24 | 19542 |
| 10/32 | 19543 |
| 1/4-20 | 19546 |
| 1/4-28 | 19547 |
| 5/16-18 | 19548 |
| 5/16-24 | 19549 |
| 3/8-16 | 19550 |
| 3/8-24 | 19551 |
| 7/16-14 | 19552 |
| 7/16-20 | 19553 |
| 1/2-13 | 19554 |
| 1/2-20 | 19555 |
| 5/8-11 | 19558 |
| 5/8-18 | 19559 |



Thin Jam Hex Nuts

| Size | Part # |
|---------|--------|
| 1/4-20 | 16546 |
| 1/4-28 | 16547 |
| 5/16-18 | 16548 |
| 5/16-24 | 16549 |
| 3/8-16 | 16550 |
| 3/8-24 | 16551 |
| 7/16-14 | 16552 |
| 7/16-20 | 16553 |
| 1/2-13 | 16554 |
| 1/2-20 | 16555 |
| 9/16-12 | 16556 |
| 9/16-18 | 16557 |
| 5/8-11 | 16558 |
| 5/8-18 | 16559 |
| 3/4-10 | 16560 |
| 3/4-16 | 16561 |

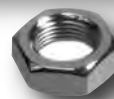

Thin Jam Flexloc Nuts (All Metal)

| Size | Part # |
|---------|--------|
| 1/4-20 | 28546 |
| 1/4-28 | 28547 |
| 5/16-18 | 28548 |
| 5/16-24 | 28549 |
| 3/8-16 | 28550 |
| 3/8-24 | 28551 |
| 7/16-14 | 28552 |
| 7/16-20 | 28553 |
| 1/2-13 | 28554 |
| 1/2-20 | 28555 |
| 9/16-12 | 28556 |
| 9/16-18 | 28557 |
| 5/8-11 | 28558 |
| 5/8-18 | 28559 |
| 3/4-10 | 28560 |
| 3/4-16 | 28561 |





Bulk Chrome Fasteners American

Nuts Chrome Plated

Acorn Nuts

Coarse and Fine Thread

| Size | Part # |
|---------|--------|
| 4/40 | 21536 |
| 6/32 | 21538 |
| 8/32 | 21540 |
| 10/24 | 21542 |
| 10/32 | 21543 |
| 12/24 | 21544 |
| 1/4-20 | 21546 |
| 1/4-28 | 21547 |
| 5/16-18 | 21548 |
| 5/16-24 | 21549 |
| 3/8-16 | 21550 |
| 3/8-24 | 21551 |
| 7/16-14 | 21552 |
| 7/16-20 | 21553 |
| 1/2-13 | 21554 |
| 1/2-20 | 21555 |
| 9/16-12 | 21556 |
| 9/16-18 | 21557 |
| 5/8-11 | 21558 |
| 5/8-18 | 21559 |
| 3/4-10 | 21560 |
| 3/4-16 | 21561 |
| 1-14 | 21565 |



Low Crown Acorn Nuts

Coarse and Fine Thread

| Size | Part # |
|---------|--------|
| 8/32 | 33540 |
| 10/24 | 33542 |
| 10/32 | 33543 |
| 1/4-20 | 33546 |
| 1/4-28 | 33547 |
| 5/16-18 | 33548 |
| 5/16-24 | 33549 |
| 3/8-16 | 33550 |
| 3/8-24 | 33551 |
| 7/16-14 | 33552 |
| 7/16-20 | 33553 |
| 1/2-13 | 33554 |
| 1/2-20 | 33555 |
| 5/8-11 | 33558 |
| 5/8-18 | 33559 |



Acorn Push On Covers

| Wrench Size | Part # | Bolt/Nut Diameter |
|-------------|--------|-------------------|
| 7/16 | 45552 | 1/4 |
| 1/2 | 45554 | 5/16 |
| 9/16 | 45556 | 3/8 |
| 5/8 | 45558 | 7/16 |
| 11/16 | 45559 | |
| 7/8 | 45562 | |
| 3/4 | 45560 | |

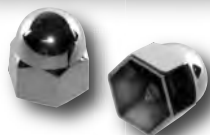

Spacers Chrome Plated

| ID | OD | Length | Part # |
|------|------|--------|---------|
| 1/4 | 7/16 | 3/16 | 20080 |
| 1/4 | 7/16 | 1/4 | 20081 |
| 1/4 | 7/16 | 3/8 | 20082 |
| 1/4 | 7/16 | 1/2 | 20082-A |
| 1/4 | 7/16 | 5/8 | 20083 |
| 1/4 | 7/16 | 3/4 | 20084 |
| 1/4 | 7/16 | 7/8 | 20094 |
| 1/4 | 7/16 | 1 1/16 | 20085 |
| 1/4 | 5/8 | 1/8 | 20040 |
| 1/4 | 5/8 | 1/4 | 20036 |
| 1/4 | 5/8 | 3/8 | 20037 |
| 1/4 | 5/8 | 1/2 | 20038 |
| 1/4 | 5/8 | 3/4 | 20039 |
| 1/4 | 5/8 | 1 | 20041 |
| 5/16 | 7/16 | 5/8 | 20045 |
| 5/16 | 1/2 | 3/16 | 20049 |
| 5/16 | 1/2 | 1/4 | 20050 |
| 5/16 | 1/2 | 3/8 | 20050-A |
| 5/16 | 1/2 | 1/2 | 20051 |
| 5/16 | 1/2 | 17/32 | 20093 |
| 5/16 | 1/2 | 3/4 | 20052 |
| 5/16 | 1/2 | 1 | 20053 |
| 5/16 | 1/2 | 1 1/4 | 20054 |
| 5/16 | 5/8 | 1/8 | 20055 |
| 5/16 | 5/8 | 3/16 | 20056 |
| 5/16 | 5/8 | 1/4 | 20057 |
| 5/16 | 5/8 | 3/8 | 20058 |
| 5/16 | 5/8 | 1/2 | 20059 |
| 5/16 | 5/8 | 3/4 | 20060 |
| 5/16 | 5/8 | 1 | 20061 |
| 3/8 | 9/16 | 1/8 | 20087 |

| ID | OD | Length | Part # |
|-------|--------|-------------|----------|
| 3/8 | 9/16 | 3/8 | 20086 |
| 3/8 | 13/16 | 5/32 | 20091 |
| 3/8 | 5/8 | 1/4 | 20067 |
| 3/8 | 5/8 | 3/8 | 20068 |
| 3/8 | 1 | 5/16 | C-31-32 |
| 3/8 | 5/8 | 1/2 | 20069 |
| 3/8 | 13/16 | 1/2 | 20092 |
| 3/8 | 5/8 | 3/4 | 20070 |
| 3/8 | 13/16 | 29/32 | 20092-A |
| 3/8 | 5/8 | 1 | 20072 |
| 3/8 | 5/8 | 1 1/2 | 20075 |
| 3/8 | 3/4 | 1/8 Tapered | 20021 |
| 3/8 | 3/4 | 1/4 | 20022 |
| 3/8 | 3/4 | 3/8 | 20023 |
| 3/8 | 3/4 | 1/2 | 20024 |
| 3/8 | 3/4 | 3/4 | 20025 |
| 3/8 | 3/4 | 1 | 20026 |
| 3/8 | 7/8 | 5/8 | 20089 |
| 7/16 | 3/4 | 3/32 | 23580 |
| 7/16 | 11/16 | 5/16 | 20088 |
| 1/2 | 5/16 | 15/16 | 20095 |
| 1/2 | 3/4 | 1/8 | 20030 |
| 1/2 | 3/4 | 1/4 | 20031 |
| 1/2 | 3/4 | 1/2 | 20032 |
| 1/2 | 3/4 | 3/4 | 20033 |
| 1/2 | 3/4 | 1 | 20034 |
| 1/2 | 7/8 | 3/8 | 20097 |
| 1/2 | 15/16 | 21/32 | 20096 |
| 1/2 | 1 1/16 | 5/16 | 23200 |
| 9/16 | 7/8 | 3/4 | 20100 |
| 5/8 | 1 1/2 | 3/8 | C-31-100 |
| 13/32 | 1 | .322 | 23327 |

Spike Nuts

Coarse and Fine Thread

| Size | Part # |
|---------|--------|
| 1/4-20 | 26546 |
| 1/4-28 | 26547 |
| 5/16-18 | 26548 |
| 5/16-24 | 26549 |
| 3/8-16 | 26550 |
| 3/8-24 | 26551 |
| 7/16-14 | 26552 |
| 7/16-20 | 26553 |
| 1/2-13 | 26554 |
| 1/2-20 | 26555 |
| 5/8-18 | 26559 |



All Items shown on this page can be purchased individually

Non-Alcoholic but may be habit forming



Spike Nuts

Bulk Chrome Fasteners American



35

Cotter Pins Chrome, Stainless or Zinc

| Size | Chrome Part # | Stainless Part # | Zinc Part # |
|--------------|---------------|------------------|-------------|
| 1/16 x 1/2 | | 78580 | 01587 |
| 1/16 x 3/4 | | 78587 | 01588 |
| 1/16 x 1 1/4 | | 78588A | 01588A |
| 5/64 x 3/4 | | 78581 | 01589 |
| 3/32 x 3/4 | 29589 | 78589 | 01590 |
| 3/32 x 1 | 29590 | 78590 | 01591 |
| 3/32 x 1 1/4 | 29591A | 78591 | |
| 3/32 x 1 1/2 | | 78591A | |
| 3/32 x 1 3/4 | 29587 | | 01592 |
| 1/8 x 3/4 | 29592 | 78592 | |
| 1/8 x 1 | | 78584 | 01593 |
| 1/8 x 1 1/4 | 29593 | 78593 | |
| 1/8 x 1 1/2 | 29585 | 78585 | |
| 1/8 x 1 3/4 | | 78585A | |
| 1/8 x 2 | | 78595 | |
| 5/32 x 1 | | 78585B | 01599 |
| 5/32 x 1 1/2 | 29588 | 78588 | |
| 5/32 x 1 3/4 | 29586 | 78586 | 01594 |
| 3/16 x 1 | 29594 | 78594 | |
| 3/16 x 1 3/4 | | 78597 | |

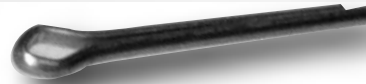

American Bulk Chrome

Cotter Pin Assortments A-34 Zinc or A-34C Chrome Plated

Flange & Locking Flange Nuts

| Size | Part # | Locking # |
|---------|--------|-----------|
| 1/4-20 | 44546 | 44546-L |
| 5/16-18 | 44548 | 44548-L |
| 5/16-24 | 44549 | 44549-L |
| 3/8-16 | 44550 | 44550-L |
| 3/8-24 | 44551 | 44551-L |
| 7/16-14 | 44552 | ---- |
| 1/2-13 | 44554 | ---- |
| 1/2-20 | 44555 | ---- |



Wide Base Wing Nut

| Size | Part # |
|--------|---------|
| 1/4-20 | 23546-W |



Grease Fittings Chrome Plated

| Size | Part # |
|-------------------|--------|
| 1/4-28 Straight | 57547 |
| 1/4-28 90° | 57548 |
| 1/4-28 45° | 57546 |
| 1/8 Pipe Straight | 57550 |
| 1/8 Pipe 45° | 57549 |



Wing Nuts

| Size | Part # |
|---------|--------|
| 1/4-20 | 23546 |
| 5/16-18 | 23548 |
| 3/8-16 | 23550 |



Allen Pipe Plugs

| Size | Part # |
|------|--------|
| 1/16 | 31587 |
| 1/8 | 31588 |
| 1/4 | 31569 |
| 3/8 | 31571 |
| 1/2 | 31573 |
| 3/4 | 31576 |



Note: See Fitting Section for more Pipe Plugs

Hole Plugs

| Size | Part # | Use with Allen Screw |
|-------|--------|----------------------|
| 3/16 | 43567 | 1/4 |
| 1/4 | 43569 | 5/16 |
| 5/16 | 43570 | 3/8 |
| 3/8 | 43571 | 7/16 |
| 7/16 | 43572 | |
| 1/2 | 43573 | |
| 5/8 | 43575 | |
| 3/4 | 43576 | |
| 7/8 | 43577 | |
| 1 | 43578 | |
| 1 1/4 | 43579 | |
| 1 1/2 | 43580 | |

Note: Hole Plugs available in Flat or Gloss black finish add - FB (flat black) or - GB (gloss black) to the end of part #

All Items shown on this page can be purchased individually

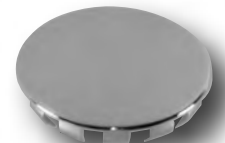



American Thread Stainless Steel

Clamps

Muffler Clamps O.D. Pipe Size Polished Stainless Steel



| Size | Part # |
|-------|----------|
| 1 3/4 | SP-67338 |
| 1 7/8 | SP-67339 |
| 2 1/4 | SP-67342 |

Line Clamps in Stainless Steel

*14 x 3/4 Drill Point Sheet Metal Screw, Stainless Steel

| Size | Part # |
|-----------|--------|
| *14 x 3/4 | 67002 |
| 3/16 | 67003 |
| 1/4 | 67004 |
| 5/16 | 67005 |
| 3/8 | 67006 |



Hose Clamps in Stainless Steel

Entire clamp is Stainless Steel including the screw. This product is manufactured in Sweden with rolled up band edges and smooth inside surface of the clamp this spares the hose and insures a high and uniform tightening force. With the flexible screwdriver you can tighten and slacken the clamp from an angle of 90° without slipping.

| Size | Min. Dia. | Max. Dia. | Part # |
|------|-----------|-----------|--------|
| 3 | 5/16 | 5/8 | 67014 |
| 4 | 7/16 | 3/4 | 67017 |
| 6 | 1/2 | 7/8 | 67020 |
| 8 | 5/8 | 1 1/16 | 67024 |
| 10 | 3/4 | 1 3/16 | 67028 |
| 12 | 7/8 | 1 7/16 | 67032 |
| 1 | 1 1/16 | 1 5/8 | 67038 |
| 20 | 1 1/4 | 1 7/8 | 67044 |
| 24 | 1 1/2 | 2 1/16 | 67050 |
| 28 | 1 3/4 | 2 3/8 | 67056 |
| 32 | 2 | 2 11/16 | 67065 |
| 36 | 2 5/16 | 3 1/8 | 67075 |
| 44 | 2 11/16 | 3 1/2 | 67085 |
| 48 | 3 | 3 7/8 | 67095 |



Screws

Carriage Bolts

| | 3/16 | 1/4 | 5/16 | 3/8 | 1/2 |
|-------|-------|-------|-------|-------|-------|
| 1/2 | 79154 | 79206 | | | |
| 3/4 | 79158 | 79210 | 79274 | 79326 | |
| 1 | 79162 | 79214 | 79280 | 79330 | 79416 |
| 1 1/2 | 79168 | 79220 | 79286 | 79336 | 79420 |
| 1 3/4 | | 79222 | | 79338 | 79422 |
| 2 | 79172 | 79224 | 79290 | 79340 | 79424 |
| 2 1/4 | | 79226 | 79292 | | |
| 2 1/2 | | 79228 | 79294 | 79334 | 79428 |
| 2 3/4 | | | 79296 | | |
| 3 | | 79232 | 79298 | 79348 | 79432 |
| 3 1/2 | | 79236 | 79302 | 79352 | 79436 |
| 4 | | 79240 | 79306 | 79356 | 79440 |
| 4 1/2 | | | | 79360 | 79442 |
| 5 | | | | 79362 | 79444 |
| 6 | | | | 79368 | 79448 |



Carriage Bolt

Note: Some larger size carriage bolt part numbers may not be listed, please call for various sizes and prices.

Bumper Bolts Stainless Steel Capped

| Size | Part # |
|--------------|--------|
| 5/16 x 3/4 | 18274 |
| 3/8 x 1 | 18330 |
| 3/8 x 1 1/2 | 18336 |
| 7/16 x 1 | 18376 |
| 7/16 x 1 1/4 | 18378 |
| 7/16 x 1 1/2 | 18380 |
| 7/16 x 1 3/4 | 18382 |
| 1/2 x 1 3/8 | 18420 |

Bumper bolt is made from Steel, Zinc Plated with a Stainless Steel cap.

Note: See carriage bolts for entire bolt made of Stainless Steel

NOTE: Add the prefix SP when ordering Polished Stainless Steel
Example: SP-18420

Bulk Stainless Fasteners American



Screws

Bowtie Hex Cap

Bowtie Hex Caps

| | 1/4 -20 | 1/4 -28 | 5/16 -18 | 5/16 -24 | 3/8 -16 | 3/8 -24 | 7/16 -14 | 7/16 -20 | 1/2 -13 | 1/2 -20 | 9/16 -12 | 9/16 -18 | 5/8 -11 | 5/8 -18 |
|-------|------------|------------|-------------|-------------|------------|------------|-------------|-------------|------------|------------|---|-------------|------------|------------|
| 1/2 | 10-77206 | 10-77207 | 10-77270 | 10-77271 | 10-77322 | 10-77323 | | | | | | | | |
| 5/8 | 10-77208 | 10-77209 | 10-77272 | 10-77273 | 10-77324 | 10-77325 | | | | | NOTE: Some 9/16 and 5/8 sizes are not listed on chart but certain sizes may be available upon request. Also add the prefix SP when ordering Polished Stainless Steel. | | | |
| 3/4 | 10-77210 | 10-77211 | 10-77274 | 10-77275 | 10-77326 | 10-77327 | 10-77374 | | | | | | | |
| 7/8 | 10-77212 | 10-77213 | 10-77278 | 10-77279 | 10-77328 | 10-77329 | | | | | | | | |
| 1 | 10-77214 | 10-77215 | 10-77280 | 10-77281 | 10-77330 | 10-77331 | 10-77376 | 10-77377 | 10-77416 | 10-77417 | | | | |
| 1 1/4 | 10-77218 | 10-77219 | 10-77284 | 10-77285 | 10-77334 | 10-77335 | 10-77378 | 10-77379 | 10-77418 | 10-77419 | 10-77454 | | | |
| 1 1/2 | 10-77220 | 10-77221 | 10-77286 | 10-77287 | 10-77336 | 10-77337 | 10-77380 | 10-77381 | 10-77420 | 10-77421 | | | | 10-77493 |
| 1 3/4 | 10-77222 | 10-77223 | 10-77288 | 10-77289 | 10-77338 | 10-77339 | 10-77382 | 10-77383 | 10-77422 | 10-77423 | | | | |
| 2 | 10-77224 | 10-77225 | 10-77290 | 10-77291 | 10-77340 | 10-77341 | 10-77384 | 10-77385 | 10-77424 | 10-77425 | 10-77460 | | | 10-77497 |
| 2 1/4 | 10-77226 | 10-77227 | 10-77292 | 10-77293 | 10-77342 | 10-77343 | 10-77386 | 10-77387 | 10-77426 | 10-77427 | | | | 10-77499 |
| 2 1/2 | 10-77228 | 10-77229 | 10-77294 | 10-77295 | 10-77344 | 10-77345 | 10-77388 | 10-77389 | 10-77428 | 10-77429 | | | | 10-77501 |
| 2 3/4 | 10-77230 | 10-77231 | 10-77296 | 10-77297 | 10-77346 | 10-77347 | 10-77390 | 10-77391 | 10-77430 | 10-77431 | | | | 10-77503 |
| 3 | 10-77232 | 10-77233 | 10-77298 | 10-77299 | 10-77348 | 10-77349 | 10-77392 | 10-77393 | 10-77432 | 10-77433 | 10-77468 | | | 10-77505 |
| 3 1/4 | 10-77234 | 10-77235 | 10-77300 | 10-77301 | 10-77350 | 10-77351 | 10-77394 | | 10-77434 | 10-77435 | | | | |
| 3 1/2 | 10-77236 | 10-77237 | 10-77302 | 10-77303 | 10-77352 | 10-77353 | 10-77396 | | 10-77436 | 10-77437 | 10-77472 | 10-77473 | | 10-77509 |
| 4 | 10-77240 | 10-77241 | 10-77306 | 10-77307 | 10-77356 | 10-77357 | 10-77400 | | 10-77440 | 10-77441 | 10-77476 | | | |
| 4 1/2 | 10-77244 | | 10-77310 | 10-77311 | 10-77360 | 10-77361 | 10-77404 | | 10-77442 | 10-77443 | 10-77478 | | 10-77514 | 10-77515 |
| 5 | 10-77246 | | 10-77312 | 10-77313 | 10-77362 | 10-77363 | 10-77406 | | 10-77444 | | 10-77480 | | 10-77516 | |
| 5 1/2 | | | 10-77316 | 10-77317 | 10-77366 | 10-77367 | 10-77410 | | 10-77446 | | 10-77482 | | 10-77518 | |
| 6 | 10-77246-A | | 10-77318 | 10-77319 | 10-77368 | 10-77369 | 10-77412 | | 10-77448 | | 10-77484 | | 10-77520 | |

You can also order the above listed Stainless Steel Part Numbers with the Emblems Stamped on the Hex Cap Bolts as shown below by using the Part Prefix associated with that emblem.

Example: Dress Up Bolt Part # 10-77210 to Purchase: 1/4-20 x 3/4 Chevy Bowtie Stamped Hex Cap in Polished Stainless Steel

Bolts are hand polished stainless steel then stamped with your choice of emblem



Chevy Bowtie
use Part Prefix
10-77xxx to order

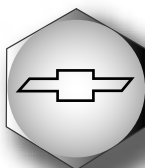

Chevy SS
use Part Prefix
13-77xxx to order



Chevy RS
use Part Prefix
16-77xxx to order



350
use Part Prefix
18-77xxx to order



454
use Part Prefix
19-77xxx to order



We also carry these other selected General Motors Emblems to choose from

Pontiac Arrow
use Part Prefix
12-77xxx to order



Pontiac GTO
use Part Prefix
20-77xxx to order



Pontiac GT
use Part Prefix
15-77xxx to order



Olds Rocket
use Part Prefix
26-77xxx to order





Bulk Stainless Steel American

Screws

Ford Oval Hex Cap



Ford Oval Hex Caps

| | 1/4 -20 | 1/4 -28 | 5/16 -18 | 5/16 -24 | 3/8 -16 | 3/8 -24 | 7/16 -14 | 7/16 -20 | 1/2 -13 | 1/2 -20 | 9/16 -12 | 9/16 -18 | 5/8 -11 | 5/8 -18 |
|-------|------------|------------|-------------|-------------|------------|------------|-------------|-------------|------------|------------|-------------|-------------|------------|------------|
| 1/2 | 11-77206 | 11-77207 | 11-77270 | 11-77271 | 11-77322 | 11-77323 | | | | | | | | |
| 5/8 | 11-77208 | 11-77209 | 11-77272 | 11-77273 | 11-77324 | 11-77325 | | | | | | | | |
| 3/4 | 11-77210 | 11-77211 | 11-77274 | 11-77275 | 11-77326 | 11-77327 | 11-77374 | | | | | | | |
| 7/8 | 11-77212 | 11-77213 | 11-77278 | 11-77279 | 11-77328 | 11-77329 | | | | | | | | |
| 1 | 11-77214 | 11-77215 | 11-77280 | 11-77281 | 11-77330 | 11-77331 | 11-77376 | 11-77377 | 11-77416 | 11-77417 | | | | |
| 1 1/4 | 11-77218 | 11-77219 | 11-77284 | 11-77285 | 11-77334 | 11-77335 | 11-77378 | 11-77379 | 11-77418 | 11-77419 | 11-77454 | | | |
| 1 1/2 | 11-77220 | 11-77221 | 11-77286 | 11-77287 | 11-77336 | 11-77337 | 11-77380 | 11-77381 | 11-77420 | 11-77421 | | | | 11-77493 |
| 1 3/4 | 11-77222 | 11-77223 | 11-77288 | 11-77289 | 11-77338 | 11-77339 | 11-77382 | 11-77383 | 11-77422 | 11-77423 | | | | |
| 2 | 11-77224 | 11-77225 | 11-77290 | 11-77291 | 11-77340 | 11-77341 | 11-77384 | 11-77385 | 11-77424 | 11-77425 | 11-77460 | | | 11-77497 |
| 2 1/4 | 11-77226 | 11-77227 | 11-77292 | 11-77293 | 11-77342 | 11-77343 | 11-77386 | 11-77387 | 11-77426 | 11-77427 | | | | 11-77499 |
| 2 1/2 | 11-77228 | 11-77229 | 11-77294 | 11-77295 | 11-77344 | 11-77345 | 11-77388 | 11-77389 | 11-77428 | 11-77429 | | | | 11-77501 |
| 2 3/4 | 11-77230 | 11-77231 | 11-77296 | 11-77297 | 11-77346 | 11-77347 | 11-77390 | 11-77391 | 11-77430 | 11-77431 | | | | 11-77503 |
| 3 | 11-77232 | 11-77233 | 11-77298 | 11-77299 | 11-77348 | 11-77349 | 11-77392 | 11-77393 | 11-77432 | 11-77433 | 11-77468 | | | 11-77505 |
| 3 1/4 | 11-77234 | 11-77235 | 11-77300 | 11-77301 | 11-77350 | 11-77351 | 11-77394 | | 11-77434 | 11-77435 | | | | |
| 3 1/2 | 11-77236 | 11-77237 | 11-77302 | 11-77303 | 11-77352 | 11-77353 | 11-77396 | | 11-77436 | 11-77437 | 11-77472 | 11-77473 | | 11-77509 |
| 4 | 11-77240 | 11-77241 | 11-77306 | 11-77307 | 11-77356 | 11-77357 | 11-77400 | | 11-77440 | 11-77441 | 11-77476 | | | |
| 4 1/2 | 11-77244 | | 11-77310 | 11-77311 | 11-77360 | 11-77361 | 11-77404 | | 11-77442 | 11-77443 | 11-77478 | | 11-77514 | 11-77515 |
| 5 | 11-77246 | | 11-77312 | 11-77313 | 11-77362 | 11-77363 | 11-77406 | | 11-77444 | | 11-77480 | | 11-77516 | |
| 5 1/2 | | | 11-77316 | 11-77317 | 11-77366 | 11-77367 | 11-77410 | | 11-77446 | | 11-77482 | | 11-77518 | |
| 6 | | | 11-77318 | 11-77319 | 11-77368 | 11-77369 | 11-77412 | | 11-77448 | | 11-77484 | | 11-77520 | |

NOTE: Some 9/16 and 5/8 sizes are not listed on chart but certain sizes may be available upon request. Also add the prefix SP when ordering Polished Stainless Steel.



You can also order the above listed Stainless Steel Part Numbers with the Emblems Stamped on the Hex Cap Bolts as shown below by using the Part Prefix associated with that emblem.

Ford Oval
use Part Prefix
11-77xxx to order



Ford V8
use Part Prefix
24-77xxx to order



Ford Mustang
use Part Prefix
25-77xxx to order



Flames
use Part Prefix
17-77xxx to order



Skulls
use Part Prefix
14-77xxx to order



Example: Dress Up Bolt Part # 11-77210 to Purchase: 1/4-20 x 3/4 Ford Oval Stamped Hex Cap in Polished Stainless Steel



Mopar
use Part Prefix
23-xxxxx to order



Chrysler Pentastar
use Part Prefix
21-xxxxx to order



Hemi Mopar
use Part Prefix
27-xxxxx to order



Dodge Ram
use Part Prefix
22-xxxxx to order



We also carry these other selected Chrysler Emblems to choose from

Bulk Stainless Fasteners American



39

Allen Screws Stainless Steel

| | 6/32 | 8/32 | 10/24 | 10/32 | 1/4 -20 | 1/4 -28 | 5/16 -18 | 5/16 -24 | 3/8 -16 | 3/8 -24 | 7/16 -14 | 1/2 -13 | 5/8 -11 |
|-------|-------|-------|-------|-------|------------|------------|-------------|-------------|------------|------------|-------------|------------|------------|
| 3/8 | 73104 | 73128 | 73152 | 73153 | 73204 | | | | | | Allen | | |
| 1/2 | 73106 | 73130 | 73154 | 73155 | 73206 | 73207 | 73270 | | 73322 | | | | |
| 5/8 | | 73132 | 73156 | 73157 | 73208 | 73209 | 73272 | 73273 | 73324 | | | | |
| 3/4 | 73110 | 73134 | 73158 | 73159 | 73210 | 73211 | 73274 | 73275 | 73326 | 73327 | 73374 | 73414 | |
| 7/8 | | 73136 | 73160 | 73161 | 73212 | | 73278 | | 73328 | | | | |
| 1 | 73114 | 73138 | 73162 | 73163 | 73214 | 73215 | 73280 | 73281 | 73330 | 73331 | 73376 | 73416 | |
| 1 1/4 | | 73140 | 73166 | 73167 | 73218 | 73219 | 73284 | 73285 | 73334 | 73335 | 73378 | 73418 | |
| 1 1/2 | | 73142 | 73168 | 73169 | 73220 | 73221 | 73286 | 73287 | 73336 | 73337 | 73380 | 73420 | 73492 |
| 1 3/4 | | | 73170 | 73171 | 73222 | 73223 | 73288 | 73289 | 73338 | 73339 | 73382 | 73422 | 73494 |
| 2 | 73122 | | 73172 | 73173 | 73224 | 73225 | 73290 | 73291 | 73340 | 73341 | 73384 | 73424 | 73496 |
| 2 1/4 | | | 73174 | | 73226 | 73227 | 73292 | | 73342 | | 73386 | 73426 | 73498 |
| 2 1/2 | | | 73176 | | 73228 | | 73294 | 73295 | 73344 | 73345 | 73388 | 73428 | 73500 |
| 2 3/4 | | | | | 73230 | | 73296 | | 73346 | | | 73430 | |
| 3 | | | | | 73232 | | 73298 | 73299 | 73348 | | 73392 | 73432 | 73504 |
| 3 1/2 | | | | | 73236 | | 73302 | | 73352 | 73353 | 73396 | 73436 | 73508 |
| 4 | | | | | 73240 | | 73306 | | 73356 | 73347 | 73400 | 73440 | 73512 |



73xxx for
Stainless
Steel
Allen with
Knurls

**American
Bulk Stainless**



SP - 73xxx for
Polished Stainless Steel
Allen with Knurls
Removed

Button Head Allen Screws

| | 6/32 | 8/32 | 10/24 | 10/32 | 1/4 -20 | 1/4 -28 | 5/16 -18 | 5/16 -24 | 3/8 -16 | 3/8 -24 | 1/2 -13 |
|-------|-------|-------|-------|-------|------------|------------|-------------|-------------|------------|------------|------------|
| 1/4 | 72102 | 72126 | 72150 | 72151 | | | | | | | |
| 3/8 | 72104 | 72128 | 72152 | 72153 | 72204 | | | | | | |
| 1/2 | 72106 | 72130 | 72154 | 72155 | 72206 | | 72270 | | 72322 | | |
| 5/8 | | 72132 | 72156 | 72157 | 72208 | | 72272 | | | | |
| 3/4 | 72110 | 72134 | 72158 | 72159 | 72210 | 72211 | 72274 | 72275 | 72326 | 72327 | |
| 1 | 72114 | 72138 | 72162 | 72163 | 72214 | 72215 | 72280 | 72281 | 72330 | 72331 | 72416 |
| 1 1/4 | | | 72166 | 72167 | 72218 | | 72284 | 72285 | 72334 | 72335 | 72418 |
| 1 1/2 | | | 72168 | 72169 | 72220 | | 72286 | 72287 | 72336 | 72337 | 72420 |
| 1 3/4 | | | | | 72222 | | | | | | |
| 2 | | | 72172 | 72173 | 72224 | | 72290 | 72291 | 72340 | | 72424 |
| 2 1/2 | | | | | | | 72294 | | 72344 | | 72428 |
| 3 | | | | | 72232 | | 72298 | | 72348 | | 72432 |
| 3 1/2 | | | | | 72236 | | | | | | |
| 4 | | | | | 72240 | | 72306 | | | | |

72xxx for
Stainless Steel
Button Head Allen



SP - 72xxx for
Polished Stainless Steel
Button Head Allen

Flat Head Allen Screws

| | 6/32 | 8/32 | 10/24 | 10/32 | 1/4 -20 | 1/4 -28 | 5/16 -18 | 5/16 -24 | 3/8 -16 | 1/2 -13 | 5/8 -11 |
|-------|-------|-------|-------|-------|------------|------------|-------------|-------------|------------|------------|------------|
| 3/8 | 71104 | | 71152 | 71153 | 71204 | | | | | | |
| 1/2 | 71106 | 71130 | 71154 | 71155 | 71206 | | 71270 | | | | |
| 5/8 | | 71132 | 71156 | 71157 | 71208 | | 71272 | | | | |
| 3/4 | | 71134 | 71158 | 71159 | 71210 | 71211 | 71274 | | 71326 | | |
| 1 | 71114 | 71138 | 71162 | 71163 | 71214 | 71215 | 71280 | 71281 | 71330 | 71416 | 71488 |
| 1 1/4 | | 71140 | 71166 | 71167 | 71218 | 71219 | 71284 | | 71334 | 71418 | 71490 |
| 1 1/2 | | 71142 | 71168 | 71169 | 71220 | 71221 | 71286 | | 71336 | 71420 | 71492 |
| 1 3/4 | | | | | 71222 | | 71288 | | 71338 | 71422 | 71494 |
| 2 | | | | | 71224 | | 71290 | | 71340 | 71424 | 71496 |
| 2 1/2 | | | | | | | | | 71344 | | |
| 3 | | | | | | | 71298 | | 71348 | 71432 | |

71xxx for
Stainless Steel
Flat Head Allen



SP - 71xxx for
Polished Stainless Steel
Flat Head Allen



Bulk Stainless Steel American

Hex Caps Screws Stainless Steel

77xxx
for Stainless Steel
Hex Cap Screws

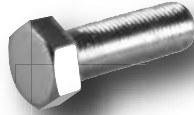

SP - 77xxx
for Polished Stainless Steel
Hex Cap Screws

NOTE: 9/16 & 5/8 sizes are not listed on chart but certain sizes may be available upon request.

| | 4/40 | 6/32 | 8/32 | 10/24 | 10/32 | 12/24 | 1/4 -20 | 1/4 -28 | 5/16 -18 | 5/16 -24 | 3/8 -16 | 3/8 -24 | 7/16 -14 | 7/16 -20 | 1/2 -13 | 1/2 -20 |
|-------|-------|-------|-------|-------|-------|-------|------------|------------|-------------|-------------|------------|------------|-------------|-------------|------------|------------|
| 3/8 | 77088 | | 77128 | 77152 | 77153 | | 77204 | 77205 | 77268 | | | | | | | |
| 1/2 | | 77106 | 77130 | 77154 | 77155 | 77186 | 77206 | 77207 | 77270 | 77271 | 77322 | 77323 | | | | |
| 5/8 | | | 77132 | 77156 | 77157 | | 77208 | 77209 | 77272 | 77273 | 77324 | 77325 | | | | |
| 3/4 | | | 77134 | 77158 | 77159 | | 77210 | 77211 | 77274 | 77275 | 77326 | 77327 | | | 77414 | |
| 7/8 | | | 77136 | | | | 77212 | 77213 | 77278 | 77279 | 77328 | 77329 | | | | |
| 1 | | 77114 | 77138 | 77162 | 77163 | 77194 | 77214 | 77215 | 77280 | 77281 | 77330 | 77331 | 77376 | 77377 | 77416 | 77417 |
| 1 1/4 | | | | 77166 | 77167 | | 77218 | 77219 | 77284 | 77285 | 77334 | 77335 | 77378 | 77379 | 77418 | 77419 |
| 1 1/2 | | | 77142 | 77168 | 77169 | | 77220 | 77221 | 77286 | 77287 | 77336 | 77337 | 77380 | 77381 | 77420 | 77421 |
| 1 3/4 | | | | | | | 77222 | 77223 | 77288 | 77289 | 77338 | 77339 | 77382 | 77383 | 77422 | 77423 |
| 2 | | | | | | | 77224 | 77225 | 77290 | 77291 | 77340 | 77341 | 77384 | 77385 | 77424 | 77425 |
| 2 1/4 | | | | | | | 77226 | 77227 | 77292 | 77293 | 77342 | 77343 | 77386 | 77387 | 77426 | 77427 |
| 2 1/2 | | | | | | | 77228 | 77229 | 77294 | 77295 | 77344 | 77345 | 77388 | 77389 | 77428 | 77429 |
| 2 3/4 | | | | | | | 77230 | 77231 | 77296 | | 77346 | | | 77391 | 77430 | |
| 3 | | | | | | | 77232 | 77233 | 77298 | 77299 | 77348 | 77349 | 77392 | 77393 | 77432 | 77433 |
| 3 1/4 | | | | | | | 77234 | | 77300 | 77301 | 77350 | | 77394 | | 77434 | 77435 |
| 3 1/2 | | | | | | | 77236 | 77237 | 77302 | | 77352 | 77353 | 77396 | | 77436 | 77437 |
| 3 3/4 | | | | | | | 77238 | | 77304 | | 77354 | | | | 77438 | |
| 4 | | | | | | | 77240 | | 77306 | | 77356 | 77357 | 77400 | | 77440 | 77441 |
| 4 1/2 | | | | | | | 77244 | | 77310 | 77311 | 77360 | 77361 | 77404 | | 77442 | 77443 |
| 5 | | | | | | | 77246 | | 77312 | 77313 | 77362 | | 77406 | | 77444 | |
| 5 1/2 | | | | | | | | | 77316 | | 77366 | | | | 77446 | |
| 6 | | | | | | | 77246-A | | 77318 | | 77368 | | 77412 | | 77448 | |

Set Screws Plain Steel

| | 6/32 | 8/32 | 10/24 | 10/32 | 1/4 -20 | 1/4 -28 | 5/16 -18 | 5/16 -24 | 3/8 -16 | 3/8 -24 |
|-------|-------|-------|-------|-------|------------|------------|-------------|-------------|------------|------------|
| 1/4 | 47102 | 47126 | 47150 | 47151 | | | | | | |
| 3/8 | 47104 | 47128 | 47152 | 47153 | 47204 | 47205 | 47268 | | | |
| 1/2 | 47106 | 47130 | 47154 | 47155 | 47206 | 47207 | 47270 | 47271 | 47322 | 47323 |
| 5/8 | 47108 | 47132 | 47156 | 47157 | 47208 | 47209 | 47272 | 47273 | 47324 | 47325 |
| 3/4 | 47110 | 47134 | 47158 | 47159 | 47210 | 47211 | 47274 | 47275 | 47326 | 47327 |
| 1 | 47114 | 47138 | 47162 | 47163 | 47214 | 47215 | 47280 | 47281 | 47330 | 47331 |
| 1 1/4 | | | 47166 | 47167 | 47218 | 47219 | 47284 | 47285 | 47334 | 47335 |
| 1 1/2 | | | 47168 | 47169 | 47220 | 47221 | 47286 | 47289 | 47336 | 47337 |
| 1 3/4 | | | | | 47222 | | 47288 | | | |
| 2 | | | | | 47224 | 47225 | 47290 | 47291 | 47340 | 47341 |
| 2 1/2 | | | | | 47228 | | 47294 | | 47344 | |

Set Screws
Sold Each



Stainless Steel Available



American Bulk Stainless

Washers Stainless Steel

Flat Washers

| Size | Part # |
|------|--------|
| 4 | 75564 |
| 6 | 75565 |
| 8 | 75566 |
| 10 | 75567 |
| 1/4 | 75569 |
| 5/16 | 75570 |
| 3/8 | 75571 |
| 7/16 | 75572 |
| 1/2 | 75573 |
| 5/8 | 75575 |
| 3/4 | 75576 |



AN Washers Small OD

| Size | Part # |
|------|--------|
| 6 | 84565 |
| 8 | 84566 |
| 10 | 84567 |
| 1/4 | 84569 |
| 5/16 | 84570 |
| 3/8 | 84571 |
| 7/16 | 84572 |
| 1/2 | 84573 |
| 5/8 | 84575 |
| 3/4 | 84576 |



Lock Washers

| Size | Part # |
|------|--------|
| 4 | 76564 |
| 6 | 76565 |
| 8 | 76566 |
| 10 | 76567 |
| 1/4 | 76569 |
| 5/16 | 76570 |
| 3/8 | 76571 |
| 7/16 | 76572 |
| 1/2 | 76573 |
| 5/8 | 76575 |
| 3/4 | 76576 |



Finishing Washers

| Size | Part # |
|------|--------|
| 6 | 78565 |
| 8 | 78566 |
| 10 | 78567 |
| 1/4 | 78569 |
| 5/16 | 78570 |



High Collar Lock Washers

| Size | Part # |
|------|--------|
| 1/4 | 80569 |
| 5/16 | 80570 |
| 3/8 | 80571 |
| 1/2 | 80573 |



All Items shown on this page can be purchased individually

GW Stainless Steel Flat Washers



| Size | Part # |
|------|--------|
| 1/4 | 70569 |
| 5/16 | 70570 |
| 3/8 | 70571 |
| 7/16 | 70572 |
| 1/2 | 70573 |
| 5/8 | 70575 |

Our Stainless Steel washer is thicker than standard flat washers and has a close tolerance ID for a snug fit. It has a standard OD so it can be used anywhere a regular washer was.

Super Flat Washers

| Size | Part # |
|--------------|-----------|
| #6 x 5/8 | 66108 |
| #8 x 3/4 | 66134 |
| 3/16 x 11/16 | 66157 |
| 3/16 x 3/4 | 66158 |
| 3/16 x 1 | 66162 |
| 3/8 x 1 | 66330 |
| 3/8 x 1 1/4 | 66334 |
| 1/4 x 1 | 66214 |
| 1/4 x 1 1/4 | 66218 |
| 5/16 x 3/4 | SP- 66274 |
| 5/16 x 1 1/2 | 66286 |
| 3/8 x 7/8 | SP- 66328 |
| 3/8 x 1 1/2 | 66336 |
| 7/16 x 1 | 66376 |
| 7/16 x 1 1/8 | SP- 66377 |
| 1/2 x 1 1/4 | SP- 66418 |
| 1/2 x 1 1/2 | 66420 |
| 1/2 x 2 | 66424 |
| 5/8 x 1 1/2 | SP- 66492 |
| 5/8 x 1 3/4 | 66494 |
| 3/4 x 1 3/4 | 66528 |

(SP-) Super Flat Washers Polished Stainless Steel in that size only

Internal Lock Washers

| Size | Part # |
|------|--------|
| 4 | 82564 |
| 6 | 82565 |
| 8 | 82566 |
| 10 | 82567 |
| 1/4 | 82569 |
| 5/16 | 82570 |
| 3/8 | 82571 |
| 7/16 | 82572 |
| 1/2 | 82573 |
| 5/8 | 82575 |



External Lock Washers

| Size | Part # |
|------|--------|
| 4 | 83564 |
| 6 | 83565 |
| 8 | 83566 |
| 10 | 83567 |
| 1/4 | 83569 |
| 5/16 | 83570 |
| 3/8 | 83571 |
| 7/16 | 83572 |
| 1/2 | 83573 |
| 5/8 | 83575 |



External Countersunk Washers

| Size | Part # |
|------|--------|
| 6 | 89565 |
| 8 | 89566 |
| 10 | 89567 |
| 1/4 | 89569 |
| 5/16 | 89570 |

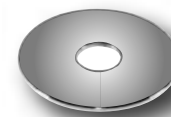



Bulk Stainless Steel American

Washers Stainless Steel

White Nylon Flat Washers

| Size | Part # |
|------|--------|
| 8 | 87566 |
| 10 | 87567 |
| 1/4 | 87569 |
| 5/16 | 87570 |
| 3/8 | 87571 |
| 7/16 | 87572 |
| 1/2 | 87573 |
| 5/8 | 87575 |



Neoprene Backed Flat Washers

| Size | Part # |
|------|--------|
| 10 | 81567 |
| 1/4 | 81569 |
| 5/16 | 81570 |
| 3/8 | 81571 |
| 1/2 | 81573 |



Available in
Stainless Steel Polished
Add SP-81xxx

Pipe Plugs Allen Style

| Size | Part # |
|------|--------|
| 1/8 | 86588 |
| 1/4 | 86569 |
| 3/8 | 86571 |
| 1/2 | 86573 |
| 3/4 | 86576 |



Threaded Rod Stainless Steel

| Size | Part # |
|---------|--------|
| 6/32 | 63122 |
| 8/32 | 63148 |
| 10/24 | 63180 |
| 10/32 | 63181 |
| 1/4-20 | 63232 |
| 1/4-28 | 63233 |
| 5/16-18 | 63298 |
| 5/16-24 | 63299 |
| 3/8-16 | 63348 |
| 3/8-24 | 63349 |
| 7/16-14 | 63392 |
| 7/16-20 | 63393 |
| 1/2-13 | 63432 |
| 1/2-20 | 63433 |
| 5/8-11 | 63504 |

All Items shown on this page can
be purchased individually

Threaded Rod
Sold in Three Foot Lengths

Nuts Stainless Steel

Acorn Nuts

| Size | Part # |
|---------|--------|
| 6/32 | 68538 |
| 8/32 | 68540 |
| 10/24 | 68542 |
| 10/32 | 68543 |
| 1/4-20 | 68546 |
| 1/4-28 | 68547 |
| 5/16-18 | 68548 |
| 5/16-24 | 68549 |
| 3/8-16 | 68550 |
| 3/8-24 | 68551 |
| 7/16-14 | 68552 |
| 7/16-20 | 68553 |
| 1/2-13 | 68554 |
| 1/2-20 | 68555 |
| 5/8-11 | 68558 |
| 5/8-18 | 68559 |



Castle Nuts

| Size | Part # |
|--------|--------|
| 3/8-24 | 81551 |
| 1/2-13 | 81554 |
| 1/2-20 | 81555 |
| 5/8-11 | 81558 |



For Stainless Steel Polished
Order with the SP-Prefix than the
five digit Part # SP-xxxxx

Hex Nuts

| Size | Part # |
|---------|--------|
| 6/32 | 70538 |
| 8/32 | 70540 |
| 10/24 | 70542 |
| 10/32 | 70543 |
| 1/4-20 | 70546 |
| 1/4-28 | 70547 |
| 5/16-18 | 70548 |
| 5/16-24 | 70549 |
| 3/8-16 | 70550 |
| 3/8-24 | 70551 |
| 7/16-14 | 70552 |
| 7/16-20 | 70553 |
| 1/2-13 | 70554 |
| 1/2-20 | 70555 |
| 9/16-12 | 70556 |
| 9/16-18 | 70557 |
| 5/8-11 | 70558 |
| 5/8-18 | 70559 |
| 3/4-10 | 70560 |
| 3/4-16 | 70561 |



Nylon Lock Nuts

| Size | Part # |
|---------|--------|
| 4/40 | 69536 |
| 6/32 | 69538 |
| 8/32 | 69540 |
| 10/24 | 69542 |
| 10/32 | 69543 |
| 1/4-20 | 69546 |
| 1/4-28 | 69547 |
| 5/16-18 | 69548 |
| 5/16-24 | 69549 |
| 3/8-16 | 69550 |
| 3/8-24 | 69551 |
| 7/16-14 | 69552 |
| 7/16-20 | 69553 |
| 1/2-13 | 69554 |
| 1/2-20 | 69555 |
| 9/16-12 | 69556 |
| 9/16-18 | 69557 |
| 5/8-11 | 69558 |
| 5/8-18 | 69559 |
| 3/4-10 | 69560 |
| 3/4-16 | 69561 |





American Bulk Stainless

Nuts Stainless Steel

Jam Nuts

| Size | Part # |
|---------|--------|
| 1/4-20 | 67546 |
| 1/4-28 | 67547 |
| 5/16-18 | 67548 |
| 5/16-24 | 67549 |
| 3/8-16 | 67550 |
| 3/8-24 | 67551 |
| 7/16-14 | 67552 |
| 7/16-20 | 67553 |
| 1/2-13 | 67554 |
| 1/2-20 | 67555 |
| 9/16-18 | 67557 |
| 5/8-11 | 67558 |
| 5/8-18 | 67559 |
| 3/4-16 | 67561 |
| 3/4-10 | 67560 |



Jam Lock Nuts

| Size | Part # |
|---------|--------|
| 1/4-20 | 66546 |
| 1/4-28 | 66547 |
| 5/16-18 | 66548 |
| 5/16-24 | 66549 |
| 3/8-16 | 66550 |
| 3/8-24 | 66551 |
| 7/16-14 | 66552 |
| 7/16-20 | 66553 |
| 1/2-13 | 66554 |
| 1/2-20 | 66555 |
| 5/8-11 | 66558 |
| 5/8-18 | 66559 |
| 3/4-16 | 66561 |



Spin Locks

| Size | Part # |
|---------|--------|
| 1/4-20 | 65546 |
| 5/16-18 | 65548 |
| 5/16-24 | 65549 |
| 3/8-16 | 65550 |
| 3/8-24 | 65551 |



All Items shown on this page can be purchased individually





Bulk Stainless Steel American

Machine and Sheet Metal Screws Stainless Steel

Example: To order a **8/32 x 5/8 Oval Phillips Machine Screw**: Use **Chart #1** for head style required, take those first two digits for the beginning part number which would be "40" Now look up the diameter and length from **Chart #2 or #3** for last three digits for **8/32 x 5/8** is "132" Put the two together for a part number of **89132**, or simply order by style and size.

Chart #1: Select Styles

| Style | Stainless Steel Slotted | Stainless Steel Phillips |
|------------|-------------------------|--------------------------|
| Round Head | 99 | 95 |
| Flat Head | 98 | 94 |
| Truss Head | 93 | 80 |
| Oval Head | 97 | 89 |
| Pan Head | 96 | 92 |
| Fillister | 78 | n/a |
| Hex | 77 | n/a |
| Round Wood | 83 | n/a |
| Flat Wood | 85 | n/a |
| Oval Wood | 84 | 81 |

Include the prefix **SP-89132** for **Stainless Steel Polished**

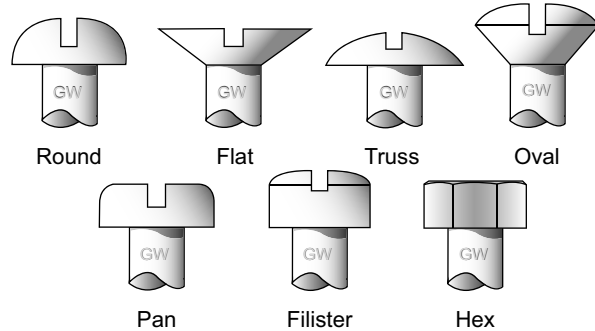

Chart #2: Machine Screw Sizes

| | 6/32 | 8/32 | 10/24 | 10/32 | 12/24 | 1/4 -20 | 1/4 -28 | 5/16 -18 | 5/16 -24 | 3/8 -16 |
|-------|------|------|-------|-------|-------|---------|---------|----------|----------|---------|
| 3/8 | 104 | 128 | 152 | 153 | 184 | 204 | | | | |
| 1/2 | 106 | 130 | 154 | 155 | 186 | 206 | | 270 | | |
| 5/8 | | 132 | 156 | 157 | 188 | 208 | 209 | | | |
| 3/4 | 110 | 134 | 158 | 159 | 190 | 210 | 211 | 274 | 275 | |
| 7/8 | | 136 | 160 | 161 | 192 | 212 | | | 279 | |
| 1 | 114 | 138 | 162 | 163 | 194 | 214 | 215 | 280 | 281 | 330 |
| 1 1/4 | 116 | 140 | 166 | 167 | 196 | 218 | 219 | 284 | 285 | 334 |
| 1 1/2 | 118 | 142 | 168 | 169 | 198 | 220 | 221 | 286 | 287 | 336 |
| 1 3/4 | | | 170 | 171 | | 222 | | 288 | 289 | 338 |
| 2 | 122 | | 172 | 173 | | 224 | | 290 | 291 | 340 |



Machine Screw

Head Styles: Oval, Flat or Pan
Note: Not all styles available in all sizes

Chart #3: Sheet Metal & Wood Screw Sizes

| | #6 | #8 | #10 | #12 | #14 |
|-------|-----|-----|-----|-----|-----|
| 1/2 | 616 | 628 | 641 | 654 | 667 |
| 5/8 | 617 | 629 | 642 | 655 | 668 |
| 3/4 | 618 | 630 | 643 | 656 | 669 |
| 1 | 620 | 632 | 645 | 658 | 671 |
| 1 1/4 | 621 | 633 | 646 | 659 | 672 |
| 1 1/2 | 622 | 634 | 647 | 660 | 673 |
| 1 3/4 | 623 | 680 | 648 | 661 | 674 |
| 2 | 624 | 635 | 649 | 662 | 675 |
| 2 1/4 | 625 | 636 | 650 | 663 | 676 |
| 2 1/2 | 626 | 637 | 651 | 664 | 677 |



Sheet Metal Screw



Woodscrew

Bulk Zinc Fasteners American



45

Hex Cap Screws Zinc Plated and L-9 Products

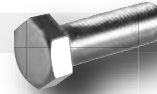

07xxx
for Grade 5
Hex Cap Screws

| | 1/4 -20 | 1/4 -28 | 5/16 -18 | 5/16 -24 | 3/8 -16 | 3/8 -24 | 7/16 -14 | 7/16 -20 | 1/2 -13 | 1/2 -20 | 5/8 -11 | 5/8 -18 |
|-------|------------|------------|-------------|-------------|------------|------------|-------------|-------------|------------|------------|------------|------------|
| 1/2 | 07206 | 07207 | 07270 | 07271 | 07322 | 07323 | | | | | | |
| 5/8 | 07208 | 07209 | 07272 | 07273 | 07324 | 07325 | | | | | | |
| 3/4 | 07210 | 07211 | 07274 | 07275 | 07326 | 07327 | 07374 | 07375 | 07414 | | | |
| 7/8 | 07212 | 07213 | 07278 | 07279 | 07328 | 07329 | | | | | | |
| 1 | 07214 | 07215 | 07280 | 07281 | 07330 | 07331 | 07376 | 07377 | 07416 | 07417 | 07488 | 07489 |
| 1 1/4 | 07218 | 07219 | 07284 | 07285 | 07334 | 07335 | 07378 | 07379 | 07418 | 07419 | 07490 | 07491 |
| 1 1/2 | 07220 | 07221 | 07286 | 07287 | 07336 | 07337 | 07380 | 07381 | 07420 | 07421 | 07492 | 07493 |
| 1 3/4 | 07222 | 07223 | 07288 | 07289 | 07338 | 07339 | 07382 | 07383 | 07422 | 07423 | 07494 | 07495 |
| 2 | 07224 | 07225 | 07290 | 07291 | 07340 | 07341 | 07384 | 07385 | 07424 | 07425 | 07496 | 07497 |
| 2 1/4 | 07226 | 07227 | 07292 | 07293 | 07342 | 07343 | 07386 | 07387 | 07426 | 07427 | 07498 | 07499 |
| 2 1/2 | 07228 | 07229 | 07294 | 07295 | 07344 | 07345 | 07388 | 07389 | 07428 | 07429 | 07500 | 07501 |
| 2 3/4 | 07230 | 07231 | 07296 | 07297 | 07346 | 07347 | 07390 | 07391 | 07430 | 07431 | 07502 | 07503 |
| 3 | 07232 | 07233 | 07298 | 07299 | 07348 | 07349 | 07392 | 07393 | 07432 | 07433 | 07504 | 07505 |
| 3 1/4 | 07234 | 07235 | 07300 | 07301 | 07350 | 07351 | 07394 | 07395 | 07434 | 07435 | 07506 | 07507 |
| 3 1/2 | 07236 | 07237 | 07302 | 07303 | 07352 | 07353 | 07396 | 07397 | 07436 | 07437 | 07508 | 07509 |
| 4 | 07240 | 07241 | 07306 | 07307 | 07356 | 07357 | 07400 | 07401 | 07440 | 07441 | 07512 | 07513 |
| 4 1/2 | 07244 | | 07310 | 07311 | 07360 | 07361 | 07404 | 07405 | 07442 | 07443 | 07514 | 07515 |
| 5 | 07246 | | 07312 | 07313 | 07362 | 07363 | 07406 | 07407 | 07444 | 07445 | 07516 | 07517 |
| 5 1/2 | | | 07316 | 07317 | 07366 | 07367 | 07410 | 07411 | 07446 | 07447 | 07518 | 07519 |
| 6 | | | | 07319 | 07368 | | 07412 | | 07448 | 07449 | 07520 | 07521 |

48xxx
for Grade 8
Hex Cap Screws
(Yellow)

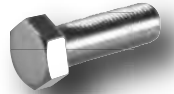

When Ordering
L-9 Zinc Plated
Hex Caps
use: 52xxx
for the first two
numers in Part #

Allen Screws Zinc Plated Grade 8



08xxx
for Grade 8
Allen Screws

NOTE: Some sizes
shown may not be
available.

| | 6/32 | 8/32 | 10/24 | 10/32 | 1/4 -20 | 1/4 -28 | 5/16 -18 | 5/16 -24 | 3/8 -16 | 3/8 -24 | 7/16 -14 | 7/16 -20 | 1/2 -13 | 1/2 -20 | 5/8 -11 | 5/8 -18 |
|-------|-------|-------|-------|-------|------------|------------|-------------|-------------|------------|------------|-------------|-------------|------------|------------|------------|------------|
| 3/8 | 08104 | 08128 | 08152 | 08153 | | | | | | | | | | | | |
| 1/2 | 08106 | 08130 | 08154 | 08155 | 08206 | 08207 | 08270 | 08271 | 08322 | 08323 | | | | | | |
| 5/8 | 08108 | 08132 | 08156 | 08157 | 08208 | 08209 | 08272 | 08273 | 08324 | 08325 | | | | | | |
| 3/4 | 08110 | 08134 | 08158 | 08159 | 08210 | 08211 | 08274 | 08275 | 08326 | 08327 | 08374 | 08375 | 08414 | 08415 | | |
| 7/8 | 08112 | 08136 | 08160 | 08161 | 08212 | 08213 | 08278 | 08279 | 08328 | 08329 | | | | | | |
| 1 | 08114 | 08138 | 08162 | 08163 | 08214 | 08215 | 08280 | 08281 | 08330 | 08331 | 08376 | 08377 | 08416 | 08417 | 08488 | 08489 |
| 1 1/4 | | 08140 | 08166 | 08167 | 08218 | 08219 | 08284 | 08285 | 08334 | 08335 | 08378 | 08379 | 08418 | 08419 | 08490 | |
| 1 1/2 | | 08142 | 08168 | 08169 | 08220 | 08221 | 08286 | 08287 | 08336 | 08337 | 08380 | 08381 | 08420 | 08421 | 08492 | 08493 |
| 1 3/4 | | | 08170 | 08171 | 08222 | 08223 | 08288 | 08289 | 08338 | 08339 | 08382 | 08383 | 08422 | 08423 | 08494 | 08495 |
| 2 | | | 08172 | 08173 | 08224 | 08225 | 08290 | 08291 | 08340 | 08341 | 08384 | 08385 | 08424 | 08425 | 08496 | 08497 |
| 2 1/4 | | | 08174 | 08175 | 08226 | 08227 | 08292 | 08293 | 08342 | 08343 | 08386 | 08387 | 08426 | 08427 | 08498 | |
| 2 1/2 | | | 08176 | 08177 | 08228 | 08229 | 08294 | 08295 | 08344 | 08345 | 08388 | 08389 | 08428 | 08429 | 08500 | |
| 2 3/4 | | | | | 08230 | 08231 | 08296 | 08297 | 08346 | 08347 | 08390 | 08391 | 08430 | 08431 | 08502 | |
| 3 | | | | | 08232 | 08233 | 08298 | 08299 | 08348 | 08349 | 08392 | 08393 | 08432 | 08433 | 08504 | |
| 3 1/4 | | | | | 08234 | | 08300 | 08301 | 08350 | 08351 | 08394 | 08395 | 08434 | 08435 | 08506 | |
| 3 1/2 | | | | | 08236 | | 08302 | 08303 | 08352 | 08353 | 08396 | 08397 | 08436 | 08437 | 08508 | |
| 4 | | | | | | | 08306 | 08307 | 08356 | | | | 08440 | 08441 | 08512 | |
| 4 1/2 | | | | | | | 08310 | 08311 | 08360 | | | | 08442 | | 08514 | |
| 5 | | | | | | | 08312 | 08313 | 08362 | | | | 08444 | | 08516 | |
| 5 1/2 | | | | | | | 08316 | 08317 | 08366 | | | | 08446 | | 08518 | |
| 6 | | | | | | | | 08319 | 08368 | | | | 08448 | | 08520 | |

American
Bulk Stainless



Bulk Zinc Fasteners American

Washers Zinc Plated and L-9 Products

Flat Washers and L-9

| Size | Part # | L-9 # |
|------|--------|-------|
| 4 | 04564 | -- |
| 6 | 04565 | -- |
| 8 | 04566 | -- |
| 10 | 04567 | -- |
| 12 | 04568 | -- |
| 1/4 | 04569 | 55569 |
| 5/16 | 04570 | 55570 |
| 3/8 | 04571 | 55571 |
| 7/16 | 04572 | 55572 |
| 1/2 | 04573 | 55573 |
| 9/16 | 04574 | 55574 |
| 5/8 | 04575 | 55575 |
| 3/4 | 04576 | -- |
| 7/8 | 04577 | -- |



Fender Washers

| Size | Part # |
|--------------|--------|
| 10 x 1 | 01567 |
| 1/4 x 1 | 01569 |
| 1/4 x 1 1/4 | 01218 |
| 1/4 x 1 1/2 | 09569 |
| 5/16 x 1 1/4 | 01284 |
| 5/16 x 1 1/2 | 01570 |
| 3/8 x 1 1/2 | 01571 |



External Lock Washers

| Size | Part # |
|------|--------|
| 4 | 02564 |
| 6 | 02565 |
| 8 | 02566 |
| 10 | 02567 |
| 12 | 02568 |
| 1/4 | 02569 |
| 5/16 | 02570 |
| 3/8 | 02571 |
| 7/16 | 02572 |
| 1/2 | 02573 |



Internal Lock Washers

| Size | Part # |
|------|--------|
| 4 | 03564 |
| 6 | 03565 |
| 8 | 03566 |
| 10 | 03567 |
| 12 | 03568 |
| 1/4 | 03569 |
| 5/16 | 03570 |
| 3/8 | 03571 |
| 7/16 | 03572 |
| 1/2 | 03573 |
| 5/8 | 03575 |
| 3/4 | 03576 |



Lock Washers and L-9

| Size | Part # | L-9 # |
|------|--------|-------|
| 4 | 05564 | -- |
| 6 | 05565 | -- |
| 8 | 05566 | -- |
| 10 | 05567 | -- |
| 12 | 05568 | -- |
| 1/4 | 05569 | 52569 |
| 5/16 | 05570 | 52570 |
| 3/8 | 05571 | 52571 |
| 7/16 | 05572 | 52572 |
| 1/2 | 05573 | 52573 |
| 9/16 | 05574 | 52574 |
| 5/8 | 05575 | 52575 |
| 3/4 | 05576 | -- |
| 7/8 | 05577 | -- |
| 1 | 05578 | -- |



Nuts Zinc Plated and L-9 Products

Hex Nuts & L-9

| Size | Part # | L-9 # |
|---------|--------|-------|
| 4/40 | 06536 | -- |
| 5/40 | 06537 | -- |
| 6/32 | 06538 | -- |
| 8/32 | 06540 | -- |
| 10/24 | 06542 | -- |
| 10/32 | 06543 | -- |
| 1/4-20 | 06546 | 52546 |
| 1/4-28 | 06547 | 52547 |
| 5/16-18 | 06548 | 52548 |
| 5/16-24 | 06549 | 52549 |
| 3/8-16 | 06550 | 52550 |
| 3/8-24 | 06551 | 52551 |
| 7/16-14 | 06552 | 52552 |
| 7/16-20 | 06553 | 52553 |
| 1/2-13 | 06554 | 52554 |
| 1/2-20 | 06555 | 52555 |
| 9/16-12 | 06556 | 06556 |
| 9/16-18 | 06557 | -- |
| 5/8-11 | 06558 | 52558 |
| 5/8-18 | 06559 | 52559 |
| 3/4-10 | 06560 | -- |
| 3/4-16 | 06561 | -- |



Nylon Lock Nuts

| Size | Part # |
|---------|--------|
| 4/40 | 03536 |
| 5/40 | 03537 |
| 6/32 | 03538 |
| 8/32 | 03540 |
| 10/24 | 03542 |
| 10/32 | 03543 |
| 1/4-20 | 03546 |
| 1/4-28 | 03547 |
| 5/16-18 | 03548 |
| 5/16-24 | 03549 |
| 3/8-16 | 03550 |
| 3/8-24 | 03551 |
| 7/16-14 | 03552 |
| 7/16-20 | 03553 |
| 1/2-13 | 03554 |
| 1/2-20 | 03555 |
| 9/16-12 | 03556 |
| 9/16-18 | 03557 |
| 5/8-11 | 03558 |
| 5/8-18 | 03559 |
| 3/4-10 | 03560 |
| 3/4-16 | 03561 |



Jam Hex Nuts

| Size | Part # |
|---------|--------|
| 1/4-20 | 04546 |
| 1/4-28 | 04547 |
| 5/16-18 | 04548 |
| 5/16-24 | 04549 |
| 3/8-16 | 04550 |
| 3/8-24 | 04551 |
| 7/16-14 | 04552 |
| 1/2-20 | 04555 |
| 9/16-18 | 04557 |
| 5/8-18 | 04559 |
| 3/4-16 | 04561 |



Jam Lock Nuts

| Size | Part # |
|---------|--------|
| 1/4-20 | 02546 |
| 1/4-28 | 02547 |
| 5/16-18 | 02548 |
| 5/16-24 | 02549 |
| 3/8-16 | 02550 |
| 3/8-24 | 02551 |
| 7/16-14 | 02552 |
| 7/16-20 | 02553 |
| 1/2-13 | 02554 |
| 1/2-20 | 02555 |
| 9/16-12 | 02556 |
| 9/16-18 | 02557 |
| 5/8-11 | 02558 |
| 5/8-18 | 02559 |



All Items shown on this page can be purchased individually



Machine and Sheet Metal Screws Zinc Plated

Example: To order a **8/32 x 5/8 Oval Phillips Machine Screw**: Use **Chart #1** for the type of head style required, take those first two digits for the beginning part number which would be **"40"**. Now look up the diameter and length from **Chart #2 or #3** for last three digits for **8/32 x 5/8** is **"132"** Put the two together for a part number of **40132**, or simply order by style and size.

Note; When placing your order please ask for Zinc Plated Screws.

Chart #1: Select Styles

Note; Not all Sizes and Styles Available

| Style | Slotted | Phillips |
|------------|---------|----------|
| Round Head | 04 | 05 |
| Flat Head | 02 | 03 |
| Truss Head | 01 | n/a |
| Pan Head | 04 | n/a |
| Fillister | 06 | n/a |



Round



Flat



Truss

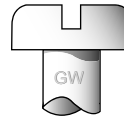

Pan



Fillister

Chart #2: Machine Screw Sizes

| | 6/32 | 8/32 | 10/24 | 10/32 | 12/24 | 1/4 -20 | 1/4 -28 | 5/16 -18 | 5/16 -24 | 3/8 -16 |
|-------|------|------|-------|-------|-------|------------|------------|-------------|-------------|------------|
| 3/8 | 104 | 128 | 152 | 153 | 184 | 204 | | | | |
| 1/2 | 106 | 130 | 154 | 155 | 186 | 206 | | 270 | | |
| 5/8 | | 132 | 156 | 157 | 188 | 208 | 209 | | | |
| 3/4 | 110 | 134 | 158 | 159 | 190 | 210 | 211 | 274 | 275 | |
| 7/8 | | 136 | 160 | 161 | 192 | 212 | | | 279 | |
| 1 | 114 | 138 | 162 | 163 | 194 | 214 | 215 | 280 | 281 | 330 |
| 1 1/4 | 116 | 140 | 166 | 167 | 196 | 218 | 219 | 284 | 285 | 334 |
| 1 1/2 | 118 | 142 | 168 | 169 | 198 | 220 | 221 | 286 | 287 | 336 |
| 1 3/4 | | | 170 | 171 | | 222 | | 288 | 289 | 338 |
| 2 | 122 | | 172 | 173 | | 224 | | 290 | 291 | 340 |

Machine Screws are sold each



Machine Screw

Chart #3: Sheet Metal Sizes

| | #6 | #8 | #10 | #12 | #14 |
|-------|-----|-----|-----|-----|-----|
| 1/2 | 616 | 628 | 641 | 654 | 667 |
| 5/8 | 617 | 629 | 642 | 655 | 668 |
| 3/4 | 618 | 630 | 643 | 656 | 669 |
| 1 | 620 | 632 | 645 | 658 | 671 |
| 1 1/4 | 621 | 633 | 646 | 659 | 672 |
| 1 1/2 | 622 | 634 | 647 | 660 | 673 |
| 1 3/4 | 623 | 680 | 648 | 661 | 674 |
| 2 | 624 | 635 | 649 | 662 | 675 |
| 2 1/4 | 625 | 636 | 650 | 663 | 676 |
| 2 1/2 | 626 | 637 | 651 | 664 | 677 |

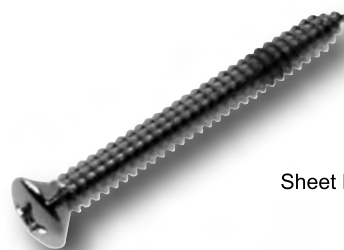

Sheet Metal Screw



We have the fasteners for any project

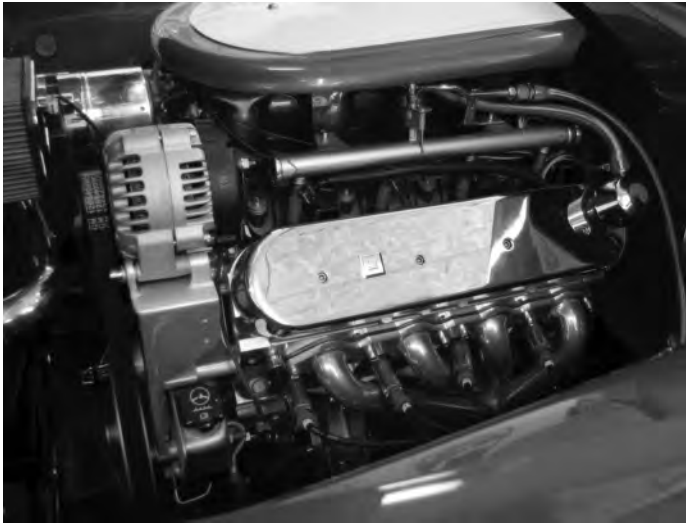



Inside This Section

Metric Thread Chrome Plated

| | |
|------------------------------------|-----------|
| <i>Allen Screws.....</i> | <i>50</i> |
| <i>Button Head Screws.....</i> | <i>50</i> |
| <i>Flat Head Allen Screws.....</i> | <i>50</i> |
| <i>Hex Cap Screws.....</i> | <i>51</i> |
| <i>12 Point Screws.....</i> | <i>51</i> |
| <i>Nuts.....</i> | <i>52</i> |
| <i>Washers.....</i> | <i>52</i> |

Metric Stainless Steel

| | |
|------------------------------------|-----------|
| <i>Allen Screws.....</i> | <i>53</i> |
| <i>Button Head Screws.....</i> | <i>53</i> |
| <i>Flat Head Allen Screws.....</i> | <i>53</i> |
| <i>Hex Caps Screws.....</i> | <i>53</i> |
| <i>Carriage Bolts.....</i> | <i>53</i> |
| <i>Washers.....</i> | <i>54</i> |
| <i>Nuts.....</i> | <i>54</i> |
| <i>Machine Screws.....</i> | <i>54</i> |

Metric Zinc Plated

| | |
|--------------------------|-----------|
| <i>Allen Screws.....</i> | <i>55</i> |
| <i>Hex Caps.....</i> | <i>55</i> |
| <i>Washers.....</i> | <i>56</i> |
| <i>Nuts.....</i> | <i>56</i> |

**Bulk Fasteners
Chrome Plated
Stainless and Zinc**





Bulk Chrome Fasteners Metric

Allen Screws Chrome Plated and Polished



For Metric Chrome Allen
with Knurls
use 12xxx



For Polished Chrome Allen
with Knurls Removed
use 10xxx

| | 4mm/ 0.7 | 5mm/ 0.8 | 6mm/ 1.0 | 8mm/ 1.25 | Fine Thread 8mm/ 1.0 | 10mm/ 1.50 | Fine Thread 10mm/ 1.25 | 12mm/ 1.75 |
|-----|-------------|-------------|-------------|--------------|----------------------------|---------------|------------------------------|---------------|
| 8 | | 12721 | 12734 | | | | | |
| 10 | 12711 | 12722 | 12735 | 12770 | | | | |
| 12 | 12712 | 12723 | 12736 | 12771 | | | | |
| 16 | 12714 | 12725 | 12738 | 12772 | | | | |
| 20 | 12715 | 12726 | 12739 | 12773 | 12773F | 12794 | 12816 | |
| 25 | 12716 | 12727 | 12740 | 12774 | 12774F | 12795 | 12817 | 12836 |
| 27 | | | 12740A | | 12775F | | | |
| 30 | 12717 | 12728 | 12741 | 12775 | 12776F | 12796 | 12818 | 12837 |
| 35 | | 12729 | 12742 | 12776 | 12777F | 12797 | 12819 | 12838 |
| 40 | | 12730 | 12743 | 12777 | 12778F | 12798 | 12820 | 12839 |
| 45 | | 12731 | 12744 | 12778 | 12779F | 12799 | 12821 | 12840 |
| 50 | | 12732 | 12745 | 12779 | | 12800 | 12822 | 12841 |
| 55 | | | 12746 | 12780 | | 12801 | 12823 | 12842 |
| 60 | | 12733 | 12747 | 12781 | | 12802 | 12824 | 12843 |
| 65 | | | 12748 | 12782 | | 12803 | 12825 | 12844 |
| 70 | | | 12749 | 12783 | | 12804 | 12826 | 12845 |
| 75 | | | 12750 | 12784 | | 12805 | 12827 | 12846 |
| 80 | | | 12751 | 12785 | | 12806 | 12828 | 12847 |
| 85 | | | | 12786 | | 12807 | 12829 | 12848 |
| 90 | | | 12753 | 12787 | | 12808 | 12830 | 12849 |
| 95 | | | 12754 | | | | | |
| 100 | | | 12755 | 12788 | | 12809 | 12831 | 12850 |
| 110 | | | 12756 | 12789 | | 12810 | | |
| 115 | | | 12756A | | | | | |
| 120 | | | 12757 | 12790 | | 12811 | | |

**Key: Read Across For Diameter
Read Down For Length**

*Call if you do not see
the sizes you need !*

Button Head Allen Screws

Flat Head Allen Screws



| | 4mm/ 0.7 | 5mm/ 0.8 | 6mm/ 1.0 | 8mm/ 1.25 | 10mm/ 1.50 | 12mm/ 1.75 |
|-----|-------------|-------------|-------------|--------------|---------------|---------------|
| 6 | 13709 | | | | | |
| 8 | 13710 | 13721 | 13734 | | | |
| 10 | 13711 | 13722 | 13735 | 13770 | | |
| 12 | 13712 | 13723 | 13736 | 13771 | | |
| 16 | 13714 | 13725 | 13738 | 13772 | 13793 | |
| 20 | 13715 | 13726 | 13739 | 13773 | 13794 | 13835 |
| 25 | 13716 | 13727 | 13740 | 13774 | 13795 | |
| 30 | | 13728 | 13741 | 13775 | 13796 | 13837 |
| 35 | | | 13742 | 13776 | 13797 | 13838 |
| 40 | 13719 | | 13743 | 13777 | 13798 | 13839 |
| 45 | | | | 13778 | 13799 | |
| 50 | | | | 13779 | 13800 | 13841 |
| 60 | | | | 13781 | 13802 | 13843 |
| 70 | | | | 13783 | 13804 | 13845 |
| 80 | | | | 13785 | 13806 | |
| 90 | | | | 13787 | 13808 | 13849 |
| 100 | | | | | | 13850 |

| | 4mm/ 0.7 | 5mm/ 0.8 | 6mm/ 1.0 | 8mm/ 1.25 | 10mm/ 1.50 |
|----|-------------|-------------|-------------|--------------|---------------|
| 6 | 14709 | | | | |
| 8 | 14710 | 14721 | 14734 | | |
| 10 | 14711 | 14722 | 14735 | | |
| 12 | 14712 | 14723 | 14736 | 14771 | |
| 16 | 14714 | 14725 | 14738 | 14772 | 14793 |
| 20 | 14715 | 14726 | 14739 | 14773 | 14794 |
| 25 | 14716 | 14727 | 14740 | 14774 | 14795 |
| 30 | 14717 | 14728 | 14741 | 14775 | 14796 |
| 35 | 14718 | 14729 | 14742 | 14776 | 14797 |
| 40 | 14719 | 14730 | 14743 | 14777 | 14798 |
| 45 | 14720A | 17731 | 17744 | 14778 | 14799 |



Hex Cap Screws Chrome Plated

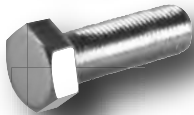

| | 4mm/ 0.7 | 5mm/ 0.8 | 6mm/ 1.0 | 7mm/ 1.0 | 8mm/ 1.25 | 10mm/ 1.50 | Fine Thread 10mm/ 1.25 | 12mm/ 1.75 | Fine Thread 12mm/ 1.50 | 14mm/ 2.00 | Fine Thread 14mm/ 1.50 |
|-----|-------------|-------------|-------------|-------------|--------------|---------------|------------------------------|---------------|------------------------------|---------------|------------------------------|
| 10 | 11711 | 11722 | 11735 | 11760 | 11770 | | | | | | |
| 16 | 11712 | 11725 | 11738 | 11762 | 11772 | 11793 | | | | | |
| 20 | 11714 | 11726 | 11739 | 11763 | 11773 | 11794 | 11816 | 11835 | 11856 | 11873 | |
| 25 | 11715 | 11727 | 11740 | 11764 | 11774 | 11795 | 11817 | 11836 | 11857 | 11874 | 11895 |
| 30 | 11716 | 11728 | 11741 | 11765 | 11775 | 11796 | 11818 | 11837 | 11858 | 11875 | |
| 35 | 11717 | 11729 | 11742 | 11766 | 11776 | 11797 | 11819 | 11838 | 11859 | 11876 | |
| 40 | | 11730 | 11743 | 11767 | 11777 | 11798 | 11820 | 11839 | 11860 | 11877 | |
| 45 | | 11731 | 11744 | | 11778 | 11799 | 11821 | 11840 | 11861 | | 11899 |
| 50 | | 11732 | 11745 | 11769 | 11779 | 11800 | 11822 | 11841 | 11862 | 11879 | |
| 55 | | | 11746 | | 11780 | 11801 | 11823 | 11842 | 11863 | | 11901 |
| 60 | | | 11747 | | 11781 | 11802 | 11824 | 11843 | 11864 | 11881 | |
| 65 | | | 11748 | | 11782 | 11803 | 11825 | 11844 | 11865 | | |
| 70 | | | 11749 | | 11783 | 11804 | 11826 | 11845 | 11866 | 11883 | |
| 75 | | | 11750 | | 11784 | 11805 | | 11846 | 11867 | | |
| 80 | | | 11751 | | 11785 | 11806 | 11828 | 11847 | 11868 | 11885 | |
| 90 | | | 11753 | | 11787 | 11808 | 11830 | 11849 | 11870 | 11887 | |
| 100 | | | 11755 | | 11788 | 11809 | 11831 | 11850 | 11871 | 11888 | |
| 110 | | | 11756 | | 11789 | 11810 | | 11851 | | | |
| 120 | | | 11757 | | 11790 | 11811 | | 11852 | | | |
| 130 | | | | | | | | 11853 | | 11891 | |
| 140 | | | | | 11792 | 11813 | | | | 11892 | |

12 Point Flange



**Key: Read Across For Diameter
Read Down For Length**

*Call if you do not see
the sizes you need !*

| | 6mm/ 1.0 | 8mm/ 1.25 | 10mm/ 1.50 | 12mm/ 1.75 |
|-----|-------------|--------------|---------------|---------------|
| 16 | 29738 | 29772 | | |
| 20 | 29739 | 29773 | | |
| 25 | 29740 | 29774 | 29795 | 29836 |
| 30 | 29741 | 29775 | 29796 | 29837 |
| 35 | 29742 | 29776 | 29797 | 29838 |
| 40 | 29743 | 29777 | 29798 | 29839 |
| 45 | 29744 | 29778 | 29799 | 29840 |
| 50 | 29745 | 29779 | 29800 | 29841 |
| 55 | | 29780 | 29801 | 29842 |
| 60 | | 29781 | 29802 | 29843 |
| 65 | | 29782 | 29803 | |
| 70 | | 29783 | 29804 | |
| 75 | | 29784 | | |
| 80 | | 29785 | 29806 | |
| 90 | | | 29807 | 29849 |
| 100 | | | 29808 | 29850 |
| 110 | | | | |
| 120 | | | | |



Demand only the finest Quality Fasteners



Bulk Chrome Fasteners Metric

Nuts Chrome Plated

Acorn Nuts

| Size | Part # |
|-------------|--------|
| 4mm x .70 | 21950 |
| 5mm x .80 | 21952 |
| 6mm x 1.0 | 21954 |
| 7mm x 1.0 | 21956 |
| 8mm x 1.0 | |
| 8mm x 1.25 | 21958 |
| 10mm x 1.25 | 21961 |
| 10mm x 1.50 | 21962 |
| 12mm x 1.25 | 21963 |
| 12mm x 1.50 | 21965 |
| 12mm x 1.75 | 21966 |



Hex Nuts

| Size | Part # |
|-------------|--------|
| 4mm x .70 | 15950 |
| 5mm x .80 | 15952 |
| 6mm x 1.0 | 15954 |
| 7mm x 1.0 | 15956 |
| 8mm x 1.0 | 15957 |
| 8mm x 1.25 | 15958 |
| 10mm x 1.25 | 15961 |
| 10mm x 1.50 | 15962 |
| 12mm x 1.25 | 15963 |
| 12mm x 1.50 | 15965 |
| 12mm x 1.75 | 15966 |
| 14mm x 1.50 | 15967 |
| 14mm x 2.00 | 15968 |
| 16mm x 1.50 | 15969 |
| 16mm x 2.00 | 15970 |

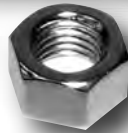

Jam Nuts

| Size | Part # |
|-------------|--------|
| 8mm x 1.0 | 16957 |
| 8mm x 1.25 | 16958 |
| 10mm x 1.25 | 16961 |
| 10mm x 1.50 | 16962 |
| 12mm x 1.25 | 16963 |
| 12mm x 1.50 | 16965 |
| 12mm x 1.75 | 16966 |
| 14mm x 1.50 | 16967 |
| 14mm x 2.00 | 16968 |
| 16mm x 1.50 | 16969 |
| 16mm x 2.00 | 16970 |



Nylon Lock Nuts

| Size | Part # |
|-------------|--------|
| 4mm x .70 | 17950 |
| 5mm x .80 | 17952 |
| 6mm x 1.0 | 17954 |
| 7mm x 1.0 | 17956 |
| 8mm x 1.0 | 17957 |
| 8mm x 1.25 | 17958 |
| 10mm x 1.25 | 17961 |
| 10mm x 1.50 | 17962 |
| 12mm x 1.25 | 17963 |
| 12mm x 1.50 | 17965 |
| 12mm x 1.75 | 17966 |
| 14mm x 1.50 | 17967 |
| 14mm x 2.00 | 17968 |
| 16mm x 1.50 | 17969 |
| 16mm x 2.00 | 17970 |



All Items shown on this page can be purchased individually

Flange Nuts

| Size | Part # |
|-------------|--------|
| 6mm x 1.0 | 44954 |
| 8mm x 1.25 | 44958 |
| 10mm x 1.50 | 44962 |
| 12mm x 1.75 | 44966 |
| 16mm x 2.0 | 44970 |



Flange Lock Nuts

| Size | Part # |
|-------------|---------|
| 8mm x 1.25 | 44958-L |
| 10mm x 1.50 | 44962-L |
| 12mm x 1.75 | 44966-L |
| 16mm x 2.0 | 44970-L |



Washers Chrome Plated

Flat Washers

| Size | Part # |
|------|--------|
| 4mm | 23985 |
| 5mm | 23986 |
| 6mm | 23987 |
| 7mm | 23988 |
| 8mm | 23989 |
| 10mm | 23990 |
| 12mm | 23991 |
| 14mm | 23992 |
| 16mm | 23993 |



Lock Washers

| Size | Part # |
|------|--------|
| 4mm | 24985 |
| 5mm | 24986 |
| 6mm | 24987 |
| 7mm | 24988 |
| 8mm | 24989 |
| 10mm | 24990 |
| 12mm | 24991 |
| 14mm | 24992 |
| 16mm | 24993 |



Wave Washers

| Size | Part # |
|------|--------|
| 8mm | 23989W |
| 12mm | 24991W |



Super Flat Washers

| Size | Part # |
|----------|--------|
| 6mm x 10 | 23735 |
| 6mm x 18 | 23278A |
| 8mm x 24 | 23773A |

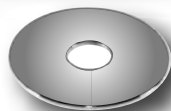

Note: See specification for dimensions
Page 4



Allen Screws Stainless Steel



73xxx for Stainless Steel Allens with Knurls or for Polished add SP-73xxx

| | 4mm/ 0.7 | 5mm/ 0.8 | 6mm/ 1.0 | 8mm/ 1.25 | 10mm/ 1.50 | 12mm/ 1.75 |
|-----|-------------|-------------|-------------|--------------|---------------|---------------|
| 8 | | 73721 | 73734 | | | |
| 10 | 73711 | 73722 | 73735 | 73770 | | |
| 12 | 73712 | 73723 | 73736 | 73771 | | |
| 16 | 73714 | 73725 | 73738 | 73772 | | |
| 20 | 73715 | 73726 | 73739 | 73773 | 73794 | 73835 |
| 25 | 73716 | 73727 | 73740 | 73774 | 73795 | 73836 |
| 30 | 73717 | 73728 | 73741 | 73775 | 73796 | 73837 |
| 35 | | 73729 | 73742 | 73776 | 73797 | 73838 |
| 40 | | 73730 | 73743 | 73777 | 73798 | 73839 |
| 45 | | 73731 | 73744 | 73778 | 73799 | 73840 |
| 50 | | 73732 | 73745 | 73779 | 73800 | 73841 |
| 55 | | | 73746 | 73780 | 73801 | 73842 |
| 60 | | | 73747 | 73781 | 73802 | 73843 |
| 65 | | | 73748 | 73782 | 73803 | 73844 |
| 70 | | | 73749 | 73783 | 73804 | 73845 |
| 75 | | | 73750 | 73784 | 73805 | 73846 |
| 80 | | | 73751 | 73785 | 73806 | 73847 |
| 90 | | | 73753 | 73787 | 73808 | 73849 |
| 100 | | | | 73788 | 73809 | 73850 |

Hex Caps Screws

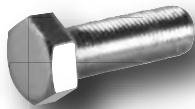

77xxx for Stainless Steel Hex Caps or for Polished add SP-77xxx

| | 4mm/ 0.7 | 5mm/ 0.8 | 6mm/ 1.0 | 8mm/ 1.25 | 10mm/ 1.50 | 12mm/ 1.75 |
|-----|-------------|-------------|-------------|--------------|---------------|---------------|
| 10 | 77711 | 77722 | 77735 | 77770 | | |
| 16 | 77714 | 77725 | 77738 | 77772 | 77793 | |
| 20 | 77715 | 77726 | 77739 | 77773 | 77794 | 77835 |
| 25 | 77716 | 77727 | 77740 | 77774 | 77795 | 77836 |
| 30 | 77717 | 77728 | 77741 | 77775 | 77796 | 77837 |
| 35 | | 77729 | 77742 | 77776 | 77797 | 77838 |
| 40 | | 77730 | 77743 | 77777 | 77798 | 77839 |
| 45 | | 77731 | 77744 | 77778 | 77799 | 77840 |
| 50 | | 77732 | 77745 | 77779 | 77800 | 77841 |
| 55 | | | 77746 | 77780 | 77801 | 77842 |
| 60 | | | 77747 | 77781 | 77802 | 77843 |
| 65 | | | 77748 | 77782 | 77803 | 77844 |
| 70 | | | 77749 | 77783 | 77804 | 77845 |
| 75 | | | 77750 | 77784 | 77805 | 77846 |
| 80 | | | 77751 | 77785 | 77806 | 77847 |
| 90 | | | 77753 | 77787 | 77808 | 77849 |
| 100 | | | 77755 | 77788 | 77809 | 77850 |
| 110 | | | 77756 | 77789 | 77810 | 77851 |

Button Head Allen Screws



72xxx for Stainless Steel Allen Button Heads or for Polished add SP-72xxx

| | 4mm/ 0.7 | 5mm/ 0.8 | 6mm/ 1.0 | 8mm/ 1.25 | 10mm/ 1.50 |
|----|-------------|-------------|-------------|--------------|---------------|
| 8 | 72710 | 72721 | 72734 | | |
| 10 | 72711 | 72722 | 72235 | 72770 | |
| 12 | 72712 | 72723 | 72736 | 72771 | |
| 16 | 72714 | 72725 | 72738 | 72772 | 72793 |
| 20 | | 72726 | 72739 | 72773 | 72794 |
| 25 | | 72727 | 72740 | 72774 | 72795 |
| 30 | | 72728 | 72741 | 72775 | 72796 |

Flat Head Allen Screws



71xxx for Stainless Steel Flat Head Allens or for Polished add SP-71xxx

| | 4mm/ 0.7 | 5mm/ 0.8 | 6mm/ 1.0 | 8mm/ 1.25 | 10mm/ 1.50 |
|----|-------------|-------------|-------------|--------------|---------------|
| 6 | 71709 | | | | |
| 8 | 71710 | 71721 | 71734 | | |
| 10 | 71711 | 71722 | 71235 | | |
| 12 | 71712 | 71723 | 71736 | 71771 | |
| 16 | 71714 | 71725 | 71738 | 71772 | 71793 |
| 20 | 71715 | 71726 | 71739 | 71173 | 71794 |
| 25 | 71716 | 71727 | 71740 | 71774 | 71795 |
| 30 | 71717 | 71728 | 71741 | 71775 | 71796 |

Carriage Bolts



79xxx for Stainless Steel Flat Head Allens or for Polished add SP-79xxx

| | 10mm/ 1.50 |
|----|---------------|
| 25 | 79795 |
| 50 | 79800 |
| 60 | 79802 |

**Key: Read Across For Diameter
Read Down For Length**

*Call if you do not see
the sizes you need !*

**Metric
Bulk Stainless**



Bulk Stainless Fasteners Metric

Washers Stainless Steel

Flat Washers

| Size | Part # |
|------|--------|
| 4mm | 75985 |
| 5mm | 75986 |
| 6mm | 75987 |
| 8mm | 75989 |
| 10mm | 75990 |
| 12mm | 75991 |
| 14mm | 75992 |
| 16mm | 75993 |



Lock Washers

| Size | Part # |
|------|--------|
| 4mm | 76985 |
| 5mm | 76986 |
| 6mm | 76987 |
| 8mm | 76989 |
| 10mm | 76990 |
| 12mm | 76991 |
| 14mm | 76992 |
| 16mm | 76993 |



Wave Washers

| Size | Part # |
|------|--------|
| 5mm | 76986W |
| 6mm | 76987W |
| 8mm | 76989W |
| 10mm | 76990W |



Example: To order a 6 x 10 Oval Phillips Machine Screw: Use **Chart #1** for head style part number which would be "89". Look up diameter and length from **Chart #2** for last three digits 6 x 10 is 735. Put the two together for a part number of **89735**, or simply order by style and size. **Include the Prefix SP-89735 for Stainless Steel Polished**



Cheesehead

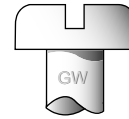

Pan



Oval

Nuts Stainless Steel

Hex Nuts

| Size | Part # |
|-------------|--------|
| 4mm x .70 | 70950 |
| 5mm x .80 | 70952 |
| 6mm x 1.0 | 70954 |
| 7mm x 1.0 | 70956 |
| 8mm x 1.25 | 70958 |
| 10mm x 1.0 | 70959 |
| 10mm x 1.25 | 70961 |
| 10mm x 1.50 | 70962 |
| 12mm x 1.50 | 70965 |
| 12mm x 1.75 | 70966 |



Jam Nuts

| Size | Part # |
|-------------|--------|
| 8mm x 1.25 | 67958 |
| 10mm x 1.50 | 67962 |
| 12mm x 1.75 | 67966 |

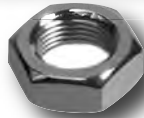

For Stainless Steel Polished Order with the SP-Prefix than the five digit Part # SP-xxxxx

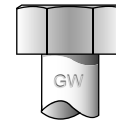

Hex



Flat

Chart #1: Select Styles

| Style | Slotted | Phillips |
|------------|---------|----------|
| Round Head | 99 | N/A |
| Flat Head | 98 | 94 |
| Truss Head | 93 | N/A |
| Oval Head | 97 | 89 |
| Pan Head | 96 | 92 |
| Cheesehead | 78 | N/A |
| Hex | 77 | N/A |

Nylon Lock Nuts

| Size | Part # |
|-------------|--------|
| 4mm x .70 | 69950 |
| 5mm x .80 | 69952 |
| 6mm x 1.0 | 69954 |
| 8mm x 1.25 | 69958 |
| 10mm x 1.50 | 69962 |
| 12mm x 1.75 | 69966 |



All Items shown on this page can be purchased individually

Chart #2: Metric Machine Screws

| | m3 | m4 | m5 | m6 | m8 |
|------|-----|-----|-----|-----|-----|
| 8mm | 701 | 710 | 721 | 734 | 770 |
| 10mm | 702 | 711 | 722 | 735 | 771 |
| 12mm | 703 | 712 | 723 | 736 | 772 |
| 16mm | 705 | 714 | 725 | 738 | 773 |
| 29mm | 706 | 715 | 726 | 739 | 774 |
| 25mm | 707 | 716 | 727 | 740 | 775 |
| 30mm | 708 | 717 | 728 | 741 | 776 |
| 35mm | | | | 742 | 777 |



Hex Cap Screws Zinc Plated

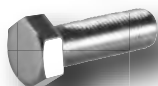

07xxx for Zinc
Hex Caps

| | 4mm/ 0.7 | 5mm/ 0.8 | 6mm/ 1.0 | 7mm/ 1.0 | 8mm/ 1.25 | 10mm/ 1.50 | Fine Thread | | |
|-----|-------------|-------------|-------------|-------------|--------------|---------------|---------------|---------------|---------------|
| | | | | | | | 10mm/ 1.25 | 12mm/ 1.75 | 12mm/ 1.50 |
| 10 | 07711 | 07722 | 07735 | 07760 | 07770 | | | | |
| 16 | 07714 | 07725 | 07738 | 07762 | 07772 | 07793 | | | |
| 20 | 07715 | 07726 | 07739 | 07763 | 07773 | 07794 | 07816 | 07835 | 07856 |
| 25 | 07716 | 07727 | 07740 | 07764 | 07774 | 07795 | 07817 | 07836 | 07857 |
| 30 | 07717 | 07728 | 07741 | 07765 | 07775 | 07796 | 07818 | 07837 | 07858 |
| 35 | | 07729 | 07742 | 07766 | 07776 | 07797 | 07819 | 07838 | 07859 |
| 40 | | 07730 | 07743 | 07767 | 07777 | 07798 | 07820 | 07839 | 07860 |
| 45 | | 07731 | 07744 | | 07778 | 07799 | 07821 | 07840 | 07861 |
| 50 | | 07732 | 07745 | 07769 | 07779 | 07800 | 07822 | 07841 | 07862 |
| 55 | | | 07746 | | 07780 | 07801 | 07823 | 07842 | 07863 |
| 60 | | | 07747 | | 07781 | 07802 | 07824 | 07843 | 07864 |
| 65 | | | 07748 | | 07782 | 07803 | 07825 | 07844 | 07865 |
| 70 | | | 07749 | | 07783 | 07804 | 07826 | 07845 | 07866 |
| 75 | | | 07750 | | 07784 | 07805 | | 07846 | 07867 |
| 80 | | | 07751 | | 07785 | 07806 | 07828 | 07847 | 07868 |
| 90 | | | 07753 | | 07787 | 07808 | 07830 | 07849 | 07870 |
| 100 | | | 07755 | | 07788 | 07809 | 07831 | 07850 | 07871 |
| 110 | | | 07756 | | 07789 | 07810 | | 07851 | 07872 |
| 120 | | | 07757 | | 07790 | 07811 | 07833 | 07852 | |

Metric
Bulk Zinc

Allen Screws Zinc Plated



For Metric Zinc Allen
with Knurls use 08xxx

Key: Read Across For Diameter
Read Down For Length

Call if you do not see
the sizes you need !

| | 4mm/ 0.7 | 5mm/ 0.8 | 6mm/ 1.0 | 8mm/ 1.25 | 8mm/ 1.0 | 10mm/ 1.50 | 10mm/ 1.25 | 12mm/ 1.75 |
|-----|-------------|-------------|-------------|--------------|-------------|---------------|---------------|---------------|
| 8 | | 08721 | 08734 | | | | | |
| 10 | 08711 | 08722 | 08735 | 08770 | | | | |
| 12 | 08712 | 08723 | 08736 | 08771 | | | | |
| 16 | 08714 | 08725 | 08738 | 08772 | | | | |
| 20 | 08715 | 08726 | 08739 | 08773 | | 08794 | | |
| 25 | 08716 | 08727 | 08740 | 08774 | 08774F | 08795 | | 08836 |
| 27 | | | 08740A | | | | | |
| 30 | 08717 | 08728 | 08741 | 08775 | 08776F | 08796 | 08818 | 08837 |
| 35 | 08718 | 08729 | 08742 | 08776 | | 08797 | 08819 | 08838 |
| 40 | 08719 | 08730 | 08743 | 08777 | 08778F | 08798 | | 08839 |
| 45 | 08720 | 08731 | 08744 | 08778 | | 08799 | 08821 | 08840 |
| 50 | 08720A | 08732 | 08745 | 08779 | | 08800 | 08822 | 08841 |
| 55 | | | 08746 | 08780 | | 08801 | | 08842 |
| 60 | | | 08747 | 08781 | | 08802 | 08824 | 08843 |
| 65 | | | 08748 | 08782 | | 08803 | 08825 | 08844 |
| 70 | | | 08749 | 08783 | | 08804 | | 08845 |
| 75 | | | 08750 | 08784 | | 08805 | | 08846 |
| 80 | | | | 08785 | | 08806 | | 08847 |
| 85 | | | | | | | 08829 | |
| 90 | | | | | | 08808 | 08830 | 08849 |
| 95 | | | | | | | | |
| 100 | | | | | | 08809 | 08831 | |
| 110 | | | | | | | | |
| 115 | | | | | | | | |
| 120 | | | | | | 08811 | | |



Bulk Zinc Fasteners Metric

Washers Zinc Plated

Flat Washers

| Size | Part # |
|------|--------|
| 4mm | 04985 |
| 5mm | 04986 |
| 6mm | 04987 |
| 8mm | 04989 |
| 10mm | 04990 |
| 12mm | 04991 |
| 14mm | 04992 |
| 16mm | 04993 |



Lock Washers

| Size | Part # |
|------|--------|
| 4mm | 05985 |
| 5mm | 05986 |
| 6mm | 05987 |
| 8mm | 05989 |
| 10mm | 05990 |
| 12mm | 05991 |
| 14mm | 05992 |
| 16mm | 05993 |



Nuts Zinc Plated

Hex Nuts

| Size | Part # |
|-------------|--------|
| 4mm x .70 | 06950 |
| 5mm x .80 | 06952 |
| 6mm x 1.0 | 06954 |
| 7mm x 1.0 | 06956 |
| 8mm x 1.0 | 06957 |
| 8mm x 1.25 | 06958 |
| 10mm x 1.25 | 06961 |
| 10mm x 1.50 | 06962 |
| 12mm x 1.25 | 06963 |
| 12mm x 1.50 | 06965 |
| 12mm x 1.75 | 06966 |
| 14mm x 1.50 | 06967 |
| 14mm x 2.00 | 06968 |
| 16mm x 1.50 | 06969 |
| 16mm x 2.00 | 06970 |

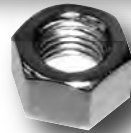

Nylon Insert Lock Nuts

| Size | Part # |
|-------------|--------|
| 4mm x .70 | 03950 |
| 5mm x .80 | 03952 |
| 6mm x 1.0 | 03954 |
| 7mm x 1.0 | 03956 |
| 8mm x 1.0 | 03957 |
| 8mm x 1.25 | 03958 |
| 10mm x 1.25 | 03961 |
| 10mm x 1.50 | 03962 |
| 12mm x 1.25 | 03963 |
| 12mm x 1.50 | 03965 |
| 12mm x 1.75 | 03966 |
| 14mm x 1.50 | 03967 |
| 14mm x 2.00 | 03968 |
| 16mm x 1.50 | 03969 |
| 16mm x 2.00 | 03970 |



Gardner-Westcott

SECOND TO NONE



Inside This Section

American Thread Chrome Plated

| | |
|------------------------------|-------|
| Tray Assortments..... | 58-59 |
| Speciality Assortments..... | 60 |
| Shop Master Assortments..... | 61 |

American Thread Stainless Steel

| | |
|-----------------------------|----|
| Tray Assortments..... | 62 |
| Allen Screws..... | 62 |
| Hex caps..... | 62 |
| Hex Nuts and Lock Nuts..... | 62 |
| Washers..... | 62 |

Zinc Plated

| | |
|----------------------------|----|
| Tray Assortments..... | 63 |
| Allen Screw..... | 63 |
| Hex Caps..... | 63 |
| Hex Nuts..... | 63 |
| Washers and Lock Nuts..... | 63 |
| The Shop Master..... | 63 |

Brass Fittings Chrome Plated

| | |
|----------------------|----|
| Tray Assortment..... | 64 |
|----------------------|----|

**Assortments in
Chrome Plated,
Stainless Steel & Zinc**

**Custom
and
Speciality
Assortments
Available**





Assortments in American Thread

Tray Assortments (Chrome Plated)

Acorn Nuts

| | | |
|--|-------|------|
| Acorn Nuts #8 thru 5/8 Coarse & Fine - (14 Sizes & 109 Pieces)..... | A-7 | ---- |
| Acorn Nuts 1/4 thru 1/2 Coarse & Fine - (12 Sizes & 120 pieces)..... | A-5 | ---- |
| Acorn Nuts Low Crown 8/32-5/8-18 - (15 Sizes & 108 Pieces)..... | A-148 | ---- |



Acorn Nut



Low Crown Acorn

Allen Head Screws

| | | |
|---|-------|--------|
| 4-40, 6/32, 8/32, 12/24 - (24 Sizes & 240 Pieces)..... | A-39 | A-39-P |
| 10/24 & 10/32 - (23 Sizes & 230 Pieces)..... | A-38 | A-38-P |
| 8/32, 10/24, 10/32, 1/4-28 - (24 Sizes & 205 Pieces)..... | A-41 | A-41-P |
| 1/4-20 - (16 Sizes & 150 Pieces)..... | A-40 | A-40-P |
| 1/4-28 - (12 Sizes & 120 Pieces)..... | A-37 | A-37-P |
| 5/16-18 - (12 Sizes & 110 Pieces)..... | A-42 | A-42-P |
| 5/16-24 - (12 Sizes & 115 Pieces)..... | A-43 | A-43-P |
| 3/8-16 - (12 Sizes & 90 Pieces)..... | A-44 | A-44-P |
| 3/8-24 - (12 Sizes & 85 Pieces)..... | A-45 | A-45-P |
| 7/16 -14 - (11 Sizes & 72 Pieces)..... | A-46 | A-46-P |
| 7/16-20 - (10 Sizes & 59 Pieces)..... | A-47 | A-47-P |
| 1/2-13 - (11 Sizes & 72 Pieces)..... | A-48 | A-48-P |
| 1/2-20 - (10 Sizes & 57 Pieces)..... | A-49 | A-49-P |
| 1/4, 5/16, 3/8 Coarse - (24 Sizes & 220 Pieces)..... | 24-CA | 24-CAP |
| 1/4, 5/16, 3/8 Fine - (23 Sizes & 210 Pieces)..... | 24-FA | 24-FAP |



Chrome Allen



Polished Allen

Body & Spinloc Bolts

| | | |
|--|-------|------|
| 1/16, 3/32, 1/8, 3/16 - (20 Sizes & 200 Pieces)..... | A-201 | ---- |
|--|-------|------|



Body Bolt

Button Head Allen Screws

| | | |
|---|-------|------|
| 8/32, 10/24, 10/32, 1/4-28 - (20 Sizes & 101 Pieces)..... | A-25 | ---- |
| 1/4-20, 5/16-18, 3/8-16 - (24 Sizes & 112 Pieces)..... | A-26 | ---- |
| 1/4-28, 5/16-18, 3/8-16 - (24 Sizes & 112 Pieces)..... | A-26F | ---- |
| 5/16-24, 3/8-24, 1/2-13 - (14 Sizes & 67 Pieces)..... | A-27 | ---- |



Button Head Allen

Cotter Pins

| | | |
|---|-------|------|
| 1/16, 3/32, 1/8, 3/16 - (9 Sizes & 425 Pieces)..... | A-34C | ---- |
|---|-------|------|

Flat Head Allen Screws

| | | |
|---|-------|------|
| 8/32, 10/24, 10/32, 1/4-28 - (24 Sizes & 240 Pieces)..... | A-10 | ---- |
| 8/32, 10/32, 1/4-28, 5/16-24, 3/8-24 - (16 Sizes & 160 Pieces)..... | A-9 | ---- |
| 1/4, 5/16, 3/8 Coarse - (24 Sizes 112 Pieces)..... | A-28 | ---- |
| 1/4, 5-16, 3/8 Fine - (24 Sizes 112 Pieces)..... | A-28F | ---- |



Flat Head Allen

Flexloc® Nuts

| | | |
|---|------|------|
| #10 thru 1/2 Coarse & Fine - (12 Sizes & 110 Pieces)..... | A-11 | ---- |
|---|------|------|



Flexloc® Nut

Flexloc® Jam Nuts

| | | |
|---|------|------|
| #10 thru 1/2 Coarse & Fine - (12 Sizes & 110 Pieces)..... | A-12 | ---- |
| Nuts & Jam Flexloc Nuts 1/4 thru 5/8 - (24 Sizes & 240 Pieces)..... | A-19 | ---- |

Flexloc® Jam Nut



Hex Cap Screws

| | | |
|---|------|------|
| 1/4, 5/16, 3/8 Coarse - (24 Sizes & 220 Pieces)..... | 24-C | ---- |
| 1/4, 5/16, 3/8 Fine - (24 Sizes & 220 Pieces)..... | 24-F | ---- |
| 7/16 & 1/2 Coarse - (11 Sizes & 80 Pieces)..... | 23-C | ---- |
| 7/16 & 1/2 Fine - (12 Sizes & 90 Pieces)..... | 23-F | ---- |
| 7/16 & 1/2 Coarse - (2 Diameters at various length with 90 Pieces)..... | 31-C | ---- |
| 7/16 & 1/2 Fine - (2 Diameters at various length with 90 Pieces)..... | 31-F | ---- |



Hex Cap

Hex Nuts

| | | |
|--|------|------|
| 6/32 thru 5/8 Coarse & Fine - (16 Sizes & 534 Pieces)..... | A-30 | ---- |
| 1/4 thru 3/8 Hex Nuts, Flat & Lock Washers - (12 Sizes & 1200 Pieces)..... | 12-W | ---- |
| 7/16 thru 5/8 Hex Nuts, Flat & Lock Washers - (12 Sizes & 540 Pieces)..... | 23-W | ---- |

Hex Nut









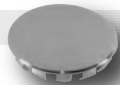
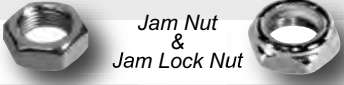

Assortments in American Thread



**Assortments
Chrome**

Tray Assortments (Chrome Plated)

| | Chrome Part # | |
|---|---------------|---|
| Fillister Head Slotted (<i>Machine Screws</i>) | | |
| 6/32 thru 1/4-20 Coarse & Fine - (24 Sizes & 240 Pieces)..... | A-179 |  Slotted Fillister |
| Flat Head Slotted (<i>Machine Screws</i>) | | |
| 6/32 thru 1/4-20 Coarse & Fine - (24 Sizes & 240 Pieces)..... | A-73-C | |
| Flat Head Slotted (<i>Sheet Metal Screws</i>) | | |
| #4 thru #14 - (23 Sizes & 230 Pieces)..... | A-75-C | |
| Hole Plugs | | |
| Brass & Chrome 3/16 thru 1 1/2 - (16 Sizes & 219 Pieces)..... | A-76 |  Hole Plug |
| Chrome 3/16 thru 3/4 - (7 Sizes & 130 Pieces)..... | A-77 | |
| Flat Black 3/16 thru 1 1/2 - (16 Sizes & 219 Pieces)..... | A-76-FB | |
| Gloss Black 3/16 thru 3/4 - (7 Sizes & 130 Pieces)..... | A-77-GB | |
| Jam Nuts & Jam Lock Nuts | | |
| 1/4 thru 5/8 Coarse & Fine - (24 Sizes & 220 Pieces)..... | A-14 |  Jam Nut & Jam Lock Nut |
| 1/4 thru 1/2 Coarse & Fine - (20 Sizes & 160 Pieces)..... | A-55 | |
| Lock Nuts Nylon Insert | | |
| #10 thru 5/8 Coarse & Fine - (11 Sizes & 190 Pieces)..... | A-8 |  Nylon Insert Lock Nut |
| 4/40 thru 3/4 Coarse & Fine - (20 Sizes & 274 Pieces)..... | A-18 | |
| Oil Line Fitting (<i>Chrome Plated Brass</i>) | | |
| Special selected fittings - (12 Sizes & 75 Pieces)..... | A-52 | (See Upper Portion of Pg. 64 For more Details) |
| Oval Head (<i>Machine Screws</i>) | | |
| 4/40 thru 3/8 Phillips Coarse & Fine - (24 Sizes & 240 Pieces)..... | A-175 |  Oval Phillips Machine Screw |
| 4/40 thru 3/8 Slotted Coarse & Fine - (24 Sizes & 240 Pieces)..... | A-176 | |
| Oval Head (<i>Sheet Metal Screws</i>) | | |
| #4 thru #14 Phillips - (24 Sizes & 240 Pieces)..... | A-202 |  Oval Slotted Machine Screw |
| #4 thru #14 Slotted - (24 Sizes & 240 Pieces)..... | A-203 | |
| Pan Head Slotted (<i>Sheet Metal Screws</i>) | | |
| #8, #10, #12 & #14 - (24 Sizes & 240 Pieces)..... | A-74-C | |
| Round Head Slotted (<i>Sheet Metal Screws</i>) | | |
| 4/40, 5/40, 6/32 & 8/32 - (23 Sizes & 230 Pieces)..... | A-71-C |  Oval Phillips Sheet Metal Screw |
| 10/24, 10/32 & 12/24 - (21 Sizes & 210 Pieces)..... | A-72-C | |
| Spacers | | (See Pg. 60 For more Details) |
| Torx Button Head | | |
| 8/32, 10/24, 10/32, 1/4-28 - (24 Sizes & 240 Pieces)..... | A-180 |  Torx Button Head |
| 1/4-20, 5/16, 3/8, 1/2 - (24 Sizes & 235 Pieces)..... | A-181 | |
| Washers | | |
| #8 thru 5/8 Flat & Lock Washers - (16 Sizes & 960 Pieces)..... | A-31 |  Flat Washer Lock Washer |
| #6 thru 5/8 Internal, External & AN - (22 Sizes & 435 Pieces)..... | A-33 | |
| Washers G-W Heat Treated | | |
| #8 thru 5/8 Flat & Lock Washers - (16 Sizes & 960 Pieces)..... | A-29 | (See Lower Portion of Pg. 60 For more Details) |
| AN #8 thru 3/4 & Std. 1/4 thru 5/8 - (21 Sizes & 435 Pieces)..... | A-160 | |
| 12 Point Screws | | |
| 1/4-20 Coarse - (16 Sizes & 155 Pieces)..... | A-240 |  12 Point Screw |
| 1/4-28 Fine - (20 Sizes & 141 Pieces)..... | A-241 | |
| 5/16-18 Coarse - (12 Sizes & 102 Pieces)..... | A-242 | |
| 5/16-24 Fine - (12 Sizes & 97 Pieces)..... | A-243 | |
| 3/8-16 Coarse - (12 Sizes & 105 Pieces)..... | A-244 | |
| 3/8-24 Fine - (12 Sizes & 105 Pieces)..... | A-245 | |
| 7/16-14 & 7/16-20 - (6 Sizes & 75 Pieces)..... | A-247 | |
| 1/2-13 & 1/2-20 - (16 Sizes & 80 Pieces)..... | A-248 | |
| 1/4, 5/16, 3/8 Coarse - (24 Sizes & 220 Pieces)..... | A-24-C | |
| 1/4, 5/16, 3/8 Fine - (24 Sizes & 220 Pieces)..... | A-24-F | |



Assortments in American Thread

Speciality Assortments (Chrome Plated)

Chrome Part # Polished Part #

Allen Head Assortment Groups (Includes; 6 Metal Trays & 1 Cabinet with items listed below)

A-40 - (1/4-20 Sizes), A-41 - (8/32, 10/24, 10/32, 1/4-28 Sizes), A-42 - (5/16-18 Sizes),
 A-43 - (5/16-24 Sizes), A-44 - (3/8-16 Sizes), A-45 - (3/8-24 Sizes)..... A-50 A-50-P

12 Point Screw Assortment Groups (Includes; 6 Metal Trays & 1 Cabinet with items listed below)

A-240 - (1/4-20 Sizes), A-241 - (1/4-28 Sizes), A-242 - (5/16-18 Sizes),
 A-243 - (5/16-24 Sizes), A-244 - (3/8-16 Sizes), A-245 - (3/8-24 Sizes)..... A-250 ---

Chrome Plated Brass Fitting Assortment (Includes; 1 Metal Tray with items listed below)

Chrome Plated Brass Fittings - (Straight Hose Barb Male Pipe Rigid, Straight
 Street Elbow, 45° Street Elbow, Hose Tee, Socket Pipe Plug, Hex Head Pipe Plug,
 Sleeve Nut & Washer Seals)..... A-52 ---

Spacer Assortments (Includes; 1 Metal Tray with a 12 or 16 size compartment either with items listed below)

Featuring 12 Sizes - (I.D.'s 3/8, 7/16 & 5/8)..... A-16 ---
 Featuring 16 Sizes - (I.D.'s 1/4 & 5/16 with Lengths from 1/4 to 1 1/4)..... A-15 ---

Spike Nuts

Featuring 11 Sizes - (11 Sizes & 78 Pieces)..... A-97 ---

Non-Alcoholic but may be habit forming



| Sizes | 1/4 -20 | 1/4 -28 | 5/16 -18 | 5/16 -24 | 3/8 -16 | 3/8 -24 |
|--------|-------------|-------------|-------------|-------------|------------|------------|
| Part # | 26546 | 26547 | 26548 | 26549 | 26550 | 26551 |
| | 7/16 -14 | 7/16 -20 | 1/2 -13 | 1/2 -20 | 5/8 -18 | |
| | 26552 | 26553 | 26554 | 26555 | 26559 | |

Can be purchased individually

The G-W Hardened Flat Washer

GARDNER-WESTCOTT COMPANY is proud to supply the first flat washer strong enough to use on motor mounts or belt sprockets and with the exceptional cosmetic quality to be used on a show bike. This hardened steel washer is thicker than standard flat washers and has a close tolerance ID for a snug fit. It has a standard OD so it can be used anywhere a regular washer was. Now available in bulk from 1/4" thru 5/8" or in Assortment # A-29 which includes; #8, #10, 1/4, 5/16, 3/8, 7/16, 1/2 and 5/8 diameter G-W Hardened Flat Washers including Lock Washers -- all show chromed, labeled and in a metal tray.



Also Available in Stainless Steel Sold Individually

G-W Heat Treated Washer & Lock Washer (Includes; 1 Metal Tray with Items Listed Below)

Chrome Part # Polished Part #

Flat Washers - (#8, #10, 1/4, 5/16, 3/8, 7/16, 1/2, 5/8)
 Lock Washers - (#8, #10, 1/4, 5/16, 3/8, 7/16, 1/2, 5/8)..... A-29 ---



**Assortments
Chrome**

MASTER ASSORTMENT

Part # A-98 consists of 6 trays (2,221 individual pieces) and includes the sliding drawer cabinet. Each tray is clearly labeled for ease in identification and re-ordering. This assortment contains 2 trays of Hex Caps 1/4, 5/16 and 3/8 inch diameter both coarse and fine thread; (Note Allen Screws or Bow Tie Hex Caps may be substituted for the Hex Caps) 1 Tray with Washers and Hex Nuts 1/4, 5/16 & 3/8 and 1 Tray each of Button Head Allens, Flat Head Allens and Oval Phillips Machine Screws.

Trays can be purchased separately also. To organize your current stock you can purchase empty trays and bins. We offer hundreds of assortments - call us to customize trays for your shop.

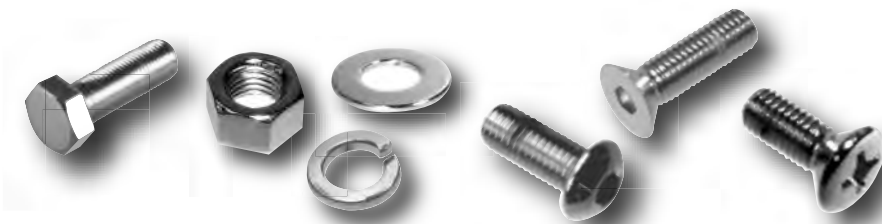

| Hex Caps | | Part # |
|--|---------------|---------|
| Coarse Thread 1/4 thru 3/8..... | 24 Sizes..... | # 24-C |
| Fine Thread 1/4 thru 3/8..... | 24 Sizes..... | # 24-F |
| Hex Nuts, Flat and Lock Washers | | |
| 1/4 thru 3/8..... | 12 Sizes..... | #12-W |
| Button Head Allen Screws | | |
| 8/32 thru 1/4-28..... | 20 Sizes..... | # A-25 |
| Flat Head Allen Screws | | |
| 8/32 thru 3/8-16..... | 24 Sizes..... | # A-10 |
| Machine Screws Oval Head Phillips | | |
| 4/40 thru 3/8-24..... | 24 Sizes..... | # A-175 |



*When You Demand The Best
Why Settle For Less...*





Assortments in American Thread

Tray Assortments (Stainless Steel)

Acorn Nuts

Acorn Nuts #8 thru 5/8 Coarse & Fine - (14 Sizes & 113 Pieces)..... A-7-S A-7-SP



Low Crown
Acorn Nut

Allen Head Screws

4-40, 6/32, 8/32, 12/24 - (24 Sizes & 240 Pieces)..... A-39-S A-39-SP

1/4-20 - (12 Sizes & 120 Pieces)..... A-40-S A-40-SP

8/32, 10/24, 10/32, 1/4-28 - (21 Sizes & 190 Pieces)..... A-41-S A-41-SP

5/16-18 - (12 Sizes & 120 Pieces)..... A-42-S A-42-SP

5/16-24 - (10 Sizes & 100 Pieces)..... A-43-S A-43-SP

3/8-16 - (12 Sizes & 90 Pieces)..... A-44-S A-44-SP

3/8-24 - (9 Sizes & 75 Pieces)..... A-45-S A-45-SP

7/16 -14 Coarse & Fine - (12 Sizes & 82 Pieces)..... A-46-S ----

1/4-28, 5/16-24, 3/8-24 Fine - (24 Sizes & 210 Pieces)..... ---- 24-FASP



Stainless Steel
Knurled Allen



Stainless Steel
Polished Allen

Allen Head Screw Assortment Group

Contains; 1 Metal Cabinet with 6 Trays & the following 6 sets

A-40-S, A-41-S, A-42-S, A-43-S, A-44-S, A-45-S - (83 Sizes & 621 Pieces)..... A-50-S A-50-SP

Button Head Allen Screws

8/32, 10/24, 10/32, 1/4-28 - (20 Sizes & 102 Pieces)..... A-25-S ----

1/4-20, 5/16-18, 3/8-16 - (24 Sizes & 114 Pieces)..... A-26-S ----

5/16-24, 3/8-24, 1/2-13 - (14 Sizes & 64 Pieces)..... A-27-S A-27-SSP



Button Head Allen

Flat Head Allen Screws

8/32, 10/24, 10/32, 1/4-28 - (20 Sizes & 200 Pieces)..... A-10-S A-10-SSP



Flat Head Allen

Hex Caps

1/4, 5/16, 3/8 Coarse - (24 Sizes & 227 Pieces)..... A-24-CS A-24-CSP

1/4, 5/16, 3/8 Fine - (24 Sizes & 227 Pieces)..... A-24-FS A-24-FSP

7/16, 1/2 Coarse & Fine - (20 Sizes & 155 Pieces)..... A-23-CS A-23-CSSP

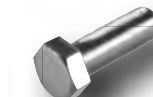

Hex Cap

Hex Nuts

6/32 thru 5/8 Coarse & Fine - (16 Sizes & 534 Pieces)..... A-30-S A-30-SP

1/4 thru 3/8 Hex Nuts, Flat & Lock Washers - (12 Sizes & 1200 Pieces)... 12-W-S 12-W-SP

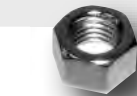

Hex Nut

Lock Nuts Nylon Insert

6/32 thru 5/8-18 Coarse & Fine - (16 Sizes & 279 Pieces)..... A-32-S A-32-SP



Nylon Insert Lock Nut

Slotted Fillister Head (Machine Screw)

6/32, 8/32, 10/24, 10/32, 12/24, 1/4 - (24 Sizes & 240 Pieces)..... A-178 ----



Slotted
Fillister

Washers

#8 thru 5/8 Flat & Lock Washers - (16 Sizes & 960 Pieces)..... A-31-S A-31-SP

#6 thru 5/8 Internal, External & AN - (22 Sizes & 880 Pieces)..... A-33-S ----



Flat & Lock Washer



Zinc Plated Fastener Assortments THE SHOP MASTER

Offering a full line of fastener assortments is important. Custom Vehicles need custom fasteners and that's why we make fastener assortments with the custom builder in mind. The organization of your stock is important, why waste time looking for a nut or bolt. **Gardner-Westcott's** assortments organize styles and sizes for fast access and easy stock control. All assortments come in metal tray and are labeled inside and outside for your convenience.....

| | Part # | Contents of each Tray |
|--------------------------------------|-------------|--|
| | A-34 | Cotter Pins |
| A-70 6 Trays in Cabinet | A-71 | Round Slotted Machine Screws 4/40 thru 8/32 |
| | A-72 | Round Slotted Machine Screws 10/24 thru 1/24 |
| | A-73 | Round Slotted Machine Screws 10/24 thru 1/24 |
| | A-74 | Pan Slotted Sheet Metal Screws #4 thru #12 |
| | A-75 | Flat Head Slotted Sheet Metal Screws #4, 6, 8, 10, 12, 1/4" |
| | A-76 | Chrome Plated Hole Plugs 3/16 thru 1/2" |
| A-90 4 Trays in Cabinet | A-91 | Hex Nuts # 4/40 thru 3/4-16 |
| | A-92 | Nylon Lock Nuts # 4/40 thru 3/4-16 |
| | A-93 | Flat Washers & Lock Washers #4 thru 3/4" |
| | A-94 | External, Internal Star, AN sm. OD & Fender lg. OD Washers |
| A-80 4 Trays in Cabinet | A-82 | Hex Cap Screws 1/4-20 and 1/4-28 |
| | A-83 | Hex Cap Screws 5/16-18 and 5/16-24 |
| | A-84 | Hex Cap Screws 3/8-16 |
| | A-85 | Hex Cap Screws 3/8-24 |
| A-81 2 Trays in Cabinet | A-86 | Hex Cap Screws 7/16-14 and 7/16-20 |
| | A-87 | Hex Cap Screws 1/2-13 and 1/2-20 |

Part # A-100



Assortments in American Thread

Hand Polished Brass Chrome Plated

Part #

Brass Fittings Chrome Plated 12 Sizes..... # A-52

includes select sizes of the following fittings: Straight Hose Barb Male Pipe Rigid, Straight Hose Barb Male Pipe Rigid, Street Elbow, 45° Street Elbow, Hose Tee, Socket Pipe Plug, Hex Head Pipe Plug, Sleeve Nut and Washer Seal.



Chrome Plated Brass
Tray Assortment #A-52

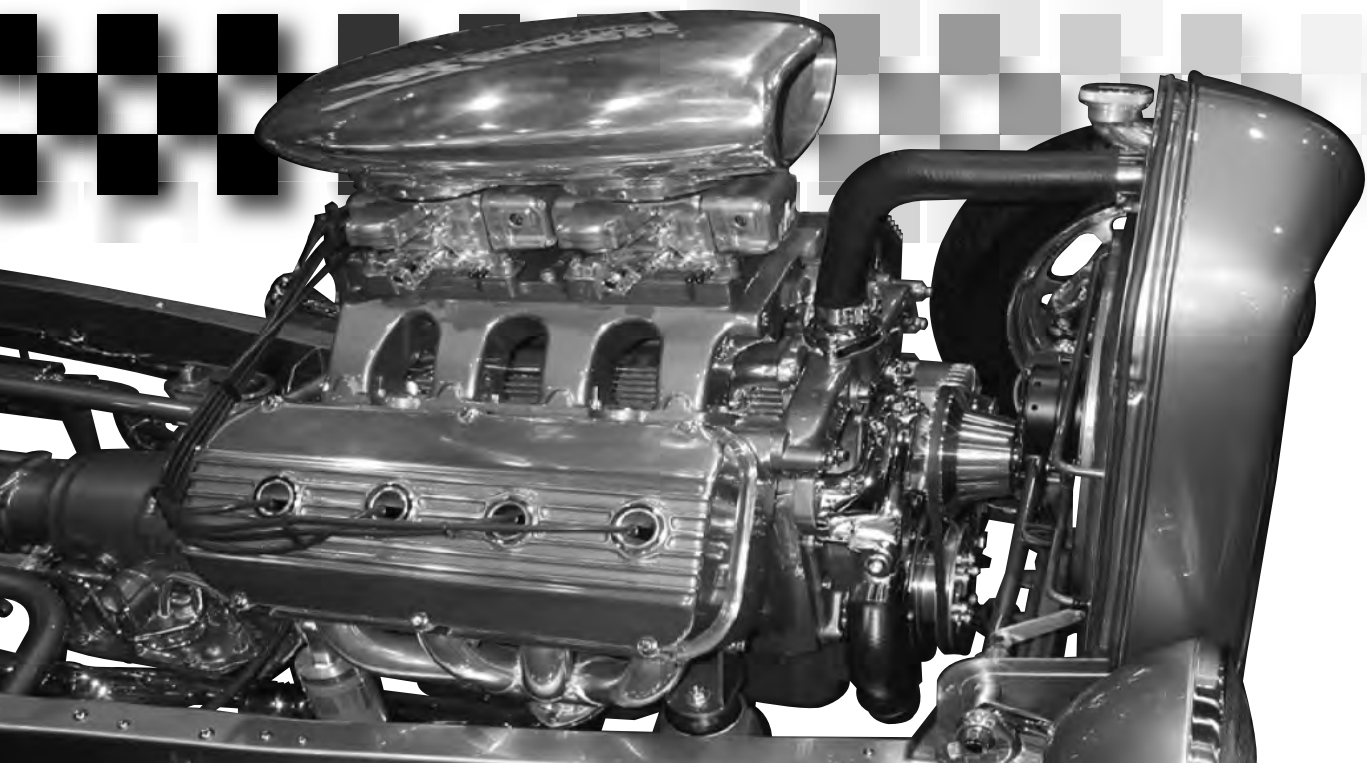

Gardner-Westcott also offers large Tray Assortments, Other Styles of Fasteners in Assortments and Custom made Assortments
Call for more information at: 1-800-521-9805
or Email us at: sales@gardner-westcott.com



Inside This Section

Metric Thread Chrome Plated

- Tray Assortments..... 66
- Acorn Nuts & Spacers..... 66
- Allen Head Screws..... 66
- Hex Caps..... 66
- Nylon Insert Lock Nuts..... 66
- Flat & Lock Washers..... 66
- Speciality Dealer Assortments..... 67

Metric Thread Stainless Steel

- Tray Assortments..... 68
- Allen Head Screws..... 68
- Hex Caps..... 68
- Hex Nuts & Lock Nuts..... 68
- Flat & Lock Washers..... 68

Metric Thread Zinc Plated

- Tray Assortments..... 68
- Allen Head Screws..... 68
- Hex Caps..... 68
- Hex Nuts & Lock Nuts..... 68
- Flat & Lock Washers..... 68

**Assortments in
Chrome Plated and
Stainless Steel**

Detailed Custom Assortments with Speciality Lengths and Diameters Available





Assortments in Metric Thread

Tray Assortments (Chrome Plated)

Acorn Nuts and Spacers Combination

Acorn Nuts 4mm thru 12mm

Spacers 1/4 x 1/4 thru 3/8 x 1 - (15 Sizes & 140 Pieces)..... A-62

Chrome
Part #

Polished
Part #



Acorn Nut

Allen Head Screws

4mm & 5mm - (24 Sizes & 210 Pieces)..... A-301-C

A-301-P

5mm & 6mm - (16 Sizes & 240 Pieces)..... A-21

A-21-P

6mm with (special 6m x 27m & 8m - 70m) - (16 Sizes & 160 Pieces)..... A-325-C

A-325-P

6mm (8m - 75m) - (24 Sizes & 120 Pieces)..... A-302-C

A-302-P

8mm x 1.25 (10m - 80m) - (16 Sizes & 130 Pieces)..... A-326-C

A-326-P

8mm x 1.25 (10m - 60m)

also 8mm x 1.0 (25m - 50m) - (16 Sizes & 124 Pieces)..... A-303-C

A-303-P

8mm (10m - 50m) & 10m x 1.50 (25m - 65m)..... -----

A-328-P

10mm x 1.50 (20m - 75m) - (12 Sizes & 95 Pieces)..... A-327-C

A-327-P

10mm x 1.50 (20m - 65m)

also 10mm x 1.25 (25m - 50m) - (16 Sizes & 120 Pieces)..... A-304-C

A-304-P

10mm x 1.50 (70m - 100m)

also 10mm x 1.25 (55m - 90m) - (12 Sizes & 60 Pieces)..... A-308-C

A-308-P

12mm x 1.75 (25m - 90m) - (12 Sizes & 60 Pieces)..... A-305-C

A-305-P



Chrome Allen



Polished Allen

Allen Screw Combination

Allens - 5mm x 12 - 10mm x 1.5 x 55

Flat Head - 4mm x 12 - 6mm x 16, 6mm x 35

Button Head - 6mm x 16 - 6mm x 30 - (25 Sizes & 205 Pieces)..... A-25-C

A-25-P



Flat
Head Allen

Button Head Allen Screws

4mm x 6m - 4m x 25, 5mm x 5 - 5m x 30

also 6mm x 8m - 6m x 35m - (23 Sizes & 230 Pieces)..... A-315



Button Head

Hex Caps

6mm x 12 - 6m x 50, 8mm x 12 - 8m x 55

also 10mm x 1.25 x 20 - 10m x 1.25 x 50 - (24 Sizes & 205 Pieces)..... 24-M

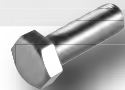

Hex Cap

Hex Nut and Nylon Insert Lock Nut Combination

Hex Nuts 4mm thru 12mm

Lock Nuts 4mm thru 12mm - (24 Sizes & 365 Pieces)..... A-61-C



Hex Nut

Flat & Lock Washer Combination

Flat Washers 3mm thru 14mm

Lock Washers 3mm thru 14mm - (16 Sizes & 430 Pieces)..... A-60-C



Flat & Lock Washers



A-326-P



A-60



A-61

Assortments in Metric Thread



**Metric
Chrome**

Metric Master Assortment

This Chrome Fastener set up will make it easy to customize your vehicle. Featuring **Metric Allen Screws**, including the following items. Flat Washers, Lock Washers, Hex Nuts and Lock Nuts all in **Show Chrome**. Contains all six metal tray assortments housed in a metal drawer cabinet.

| | | |
|---------|--|--|
| A-301-P | | Allen Screws 4mm and 5mm |
| A-325-P | | Allen Screws 6mm |
| A-326-P | | Allen Screws 8mm |
| A-327-P | | Allen Screws 10mm |
| A-60 | | Flat Washers and Lock Washers |
| A-61 | | Hex Nuts and Lock Nuts |

All above is in Cabinet **Part # A-330-P** with Polished Chrome Allens, it is also available with Knurled Chrome Allens in Cabinet **Part # A-330-C**.

Metric Assortments

Part # A-300-P is specially designed for the builder in mind. This assortment offers a wide range of sizes starting at 4mm up to 12mm. Includes special fine thread 8 & 10mm and also with longer lengths. The six metal trays are clearly labeled for ease in identification and the assortment includes the cabinet.

| | | | | | |
|-------------------------------|---------------|---|---|---------------|-------------------------------|
| | A-301-P | | Allen Screws 4mm and 5mm | | |
| | A-302-P | | Allen Screws 6mm | | |
| | A-303-P | | Allen Screws 8mm Coarse & Fine | | |
| | A-304-P | | Allen Screws 10mm Coarse & Fine | | |
| | A-308-P | | Allen Screws 10mm Long Coarse & Fine | | |
| | A-305-P | | Allen Screws 12mm | | |
| Not included order separately | A-60-C | Part #A-60-C includes Chrome Flat Washers and Lock Washers 3mm to 14mm | | A-61-C | Not included order separately |
| | | Part #A-61-C includes Hex Nuts and Lock Nuts in coarse and fine thread 4mm to 12mm | | | |



Assortments in Metric Thread

Tray Assortments (Stainless Steel)

Allen Head Screws

| | Stainless Part # | Polished Part # |
|--|------------------|-----------------|
| 5mm & 6mm - (16 Sizes & 200 Pieces)..... | A-64 | A-64-SP |
| 4mm & 5mm - (24 Sizes & 205 Pieces)..... | A-301-S | A-301-SP |
| 6mm x 1.0 x 8 thru 6mm x 1.0 x 75 - (16 Sizes & 140 Pieces)..... | A-302-S | A-302-SP |
| 8mm x 1.25 x 12 thru 8mm x 1.25 x 80 - (15 Sizes & 120 Pieces)..... | A-326-S | A-326-SP |
| 8mm x 1.25 x 10 thru 8mm x 1.25 x 80 - (16 Sizes & 124 Pieces)..... | A-303-S | A-303-SP |
| 10mm x 20 thru 10mm x 75 - (12 Sizes & 95 Pieces)..... | A-327-S | A-327-SP |
| 10mm x 1.50 x 20 thru 10mm x 1.50 x 75 - (12 Sizes & 90 Pieces)..... | A-304-S | A-304-SP |
| 12mm x 1.75 x 25 thru 12mm x 1.75 x 90 - (12 Sizes & 60 Pieces)..... | A-305-S | A-305-SP |



Stainless Steel
Knurled Allen



Stainless Steel
Polished Allen

Hex Caps

| | | |
|--|-------|---------|
| 6mm x 12 thru 8mm x 1.25 x 50 - (16 Sizes & 160 Pieces)..... | A-63 | A-63-SP |
| 6mm x 12 - 6m x 50, 8mm x 12 - 8m x 55 also 10mm x 1.25 x 20 - 10m x 1.25 x 50 - (24 Sizes & 205 Pieces)..... | 24-MS | ----- |

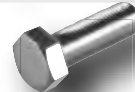

Hex Cap

Hex Nut and Nylon Insert Lock Nut Combination

| | | |
|--|--------|---------|
| Hex Nuts 4mm thru 12mm Lock Nuts 4mm thru 12mm - (24 Sizes & 365 Pieces)..... | A-65-S | A-65-SP |
|--|--------|---------|

Flat & Lock Washer Combination

| | | |
|---|--------|---------|
| Flat Washers 3mm thru 14mm Lock Washers 3mm thru 14mm - (16 Sizes & 430 Pieces)..... | A-60-S | A-60-SP |
|---|--------|---------|

Tray Assortments (Zinc)

Allen Head Screws

| | Zinc Part # |
|---|-------------|
| 4mm & 5mm - (24 Sizes & 205 Pieces)..... | A-301-Z |
| 6mm x 1.0 x 8 thru 6mm x 1.0 x 75 - (16 Sizes & 140 Pieces)..... | A-325-Z |
| 8mm x 1.25 x 10 thru 8mm x 1.25 x 80 - (16 Sizes & 124 Pieces)..... | A-326-Z |
| 10mm x 1.50 x 20 thru 10mm x 1.50 x 75 - (12 Sizes & 90 Pieces)..... | A-327-Z |
| 12mm x 1.75 x 25 thru 12mm x 1.75 x 90 - (12 Sizes & 60 Pieces)..... | A-305-Z |
| 8mm x 1.25 x 10 thru 8mm x 1.25 x 80 - (16 Sizes & 124 Pieces)..... | A-303-Z |
| 10mm x 1.50 x 20 thru 10mm x 1.50 x 75 - (12 Sizes & 90 Pieces)..... | A-304-Z |
| 10mm x 1.50 x 20 thru 10mm x 1.50 x 75 - Long - (12 Sizes & 90 Pieces)..... | A-308-Z |

Stainless Steel
Knurled Allen



Master Metric Zinc Allen Assortment

| | |
|--|---------|
| 4mm & 5mm, 8mm x 1.25, 8mm x 1.0, 10mm x 1.25, 10mm x 1.50, 12mm x 1.75 x 90, 4mm thru 12mm Hex Nuts, Lock Nuts, Flat Washers & Lock Washers all in a (6) trayed cabinet..... | A-300-Z |
|--|---------|

Hex Caps

| | |
|--|----------|
| 6mm x 1.0 x 8 thru 6mm x 1.0 x 75 - (16 Sizes & 140 Pieces)..... | A-302-HZ |
| 6mm x 1.0 x 8 thru 6mm x 1.0 x 75 - (16 Sizes & 140 Pieces)..... | A-325-HZ |
| 10mm x 20 thru 10mm x 75 - (12 Sizes & 95 Pieces)..... | A-327-HZ |
| 12mm x 1.75 x 25 thru 12mm x 1.75 x 90 - (12 Sizes & 60 Pieces)..... | A-305-HZ |
| 6mm, 8mm & 10mm - Long - (24 Sizes & 205 Pieces)..... | A-24M-HZ |



Nylon Insert
Lock Nut

Hex Nut and Nylon Insert Lock Nut Combination

| | |
|--|--------|
| Hex Nuts & Nylon Insert Lock Nuts 4mm thru 12mm - (24 Sizes & 365 Pieces)..... | A-61-Z |
|--|--------|



Hex Nut

Flat & Lock Washer Combination

| | |
|--|--------|
| Flat Washers & Lock Washers 3mm thru 14mm - (16 Sizes & 430 Pieces)..... | A-60-Z |
|--|--------|

Flat & Lock
Washers

Flat & Lock Washer Hex Nuts Combination

| | |
|--|----------|
| Flat Washers, Lock Washers & Hex Nuts 6mm, 8mm & 10mm..... | A-12-WMZ |
|--|----------|





Inside This Section

Fittings

| | |
|--------------------------------------|-------|
| <i>Pipe Fittings</i> | 70-71 |
| <i>Inverted Flare Fittings</i> | 71-72 |
| <i>Compression Fittings</i> | 72-73 |
| <i>Special Fittings</i> | 73 |
| <i>Vacuum Connectors</i> | 74 |

**Chrome and Brass
Fittings**





Pipe Fittings

Pipe Fittings

Straight Hose Barb Male Pipe

| Hose Size | Pipe Size | Brass Part # | Chrome Part # |
|-----------|-----------|--------------|---------------|
| 3/8 | 1/8 | 90TD-6 x 2 | 7-90TD-6 x 2 |
| 1/4 | 1/8 | 90TD-4 x 2 | 7-90TD-4 x 2 |
| 3/8 | 1/4 | 90TD-6 x 4 | 7-90TD-6 x 4 |
| 1/2 | 1/4 | 90TD-8 x 4 | 7-90TD-8 x 4 |



Straight Hose Barb Male Pipe

| Hose Size | Pipe Size | Brass Part # | Chrome Part # |
|-----------|-----------|--------------|---------------|
| 3/16 | 1/8 | 90HB-3 x 2 | 7-90HB-3 x 2 |
| 1/4 | 1/8 | 90HB-4 x 2 | 7-90HB-4 x 2 |
| 1/4 | 1/4 | 90HB-4 x 4 | 7-90HB-4 x 4 |
| 5/16 | 1/8 | 90HB-5 x 2 | 7-90HB-5 x 2 |
| 5/16 | 1/4 | 90HB-5 x 4 | 7-90HB-5 x 4 |
| 3/8 | 1/8 | 90HB-6 x 2 | 7-90HB-6 x 2 |
| 3/8 | 1/4 | 90HB-6 x 4 | 7-90HB-6 x 4 |



90° Hose Barb Male Pipe

| Hose Size | Pipe Size | Brass Part # | Chrome Part # |
|-----------|-----------|--------------|---------------|
| 1/4 | 1/8 | 91HB-4 x 2 | 7-91HB-4 x 2 |
| 1/4 | 1/4 | 91HB-4 x 4 | 7-91HB-4 x 4 |
| 5/16 | 1/8 | 91HB-5 x 2 | 7-91HB-5 x 2 |
| 5/16 | 1/4 | 91HB-5 x 4 | 7-91HB-5 x 4 |
| 3/8 | 1/8 | 91HB-6 x 2 | 7-91HB-6 x 2 |
| 3/8 | 1/4 | 91HB-6 x 4 | 7-91HB-6 x 4 |
| 3/8 | 3/8 | 91HB-6 x 6 | 7-91HB-6 x 6 |



Street Elbows

| Pipe Size | Brass Part # | Chrome Part # |
|-----------|--------------|---------------|
| 1/8 | 116PSE-2 | 7-116PSE-2 |
| 1/4 | 116PSE-4 | 7-116PSE-4 |
| 3/8 | 116PSE-6 | 7-116PSE-6 |



Street Elbows 45°

| Pipe Size | Brass Part # | Chrome Part # |
|-----------|--------------|---------------|
| 1/8 | 124PSE-2 | 7-124PSE-2 |
| 1/4 | 124PSE-4 | 7-124PSE-4 |
| 3/8 | 124PSE-6 | 7-124PSE-6 |



Socket Pipe Plug

| Pipe Size | Brass Part # | Chrome Part # |
|-----------|--------------|---------------|
| 1/8 | 107CSP-2 | 7-107CSP-2 |
| 1/4 | 107CSP-4 | 7-107CSP-4 |
| 3/8 | 107CSP-6 | 7-107CSP-6 |



Slotted Pipe Plug

| Pipe Size | Brass Part # | Chrome Part # |
|-----------|--------------|---------------|
| 1/8 | 117SPP-2 | 7-117SPP-2 |
| 1/4 | 117SPP-4 | 7-117SPP-4 |
| 3/8 | 117SPP-6 | 7-117SPP-6 |



Hex Head Pipe Plug

| Pipe Size | Brass Part # | Chrome Part # |
|-----------|--------------|---------------|
| 1/8 | 121PP-2 | 7-121PP-2 |
| 1/4 | 121PP-4 | 7-121PP-4 |
| 3/8 | 121PP-6 | 7-121PP-6 |
| 1/2 | 121PP-8 | 7-121PP-8 |

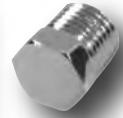

Square Head Pipe Plug

| Pipe Size | Brass Part # | Chrome Part # |
|-----------|--------------|---------------|
| 1/8 | 109PP-2 | 7-109PP-2 |
| 1/4 | 109PP-4 | 7-109PP-4 |
| 3/8 | 109PP-6 | 7-109PP-6 |
| 1/2 | 109PP-8 | 7-109PP-8 |

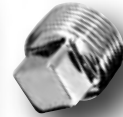

Close Nipple

| Pipe Size | Brass Part # | Chrome Part # |
|-----------|--------------|---------------|
| 1/8 | 112PCN-2 | 7-112PCN-2 |
| 1/4 | 112PCN-4 | 7-112PCN-4 |
| 3/8 | 112PCN-6 | 7-112PCN-6 |



Long Nipple

| Pipe Size | Brass Part # | Chrome Part # |
|-------------|----------------|------------------|
| 1/8 x 1 1/2 | 113PLN-2 x 1.5 | 7-113PLN-2 x 1.5 |
| 1/8 x 2 | 113PLN-2 x 2 | 7-113PLN-2 x 2 |
| 1/8 x 2 1/2 | 113PLN-2 x 2.5 | 7-113PLN-2 x 2.5 |
| 1/8 x 3 | 113PLN-2 x 3 | 7-113PLN-2 x 3 |
| 1/4 x 1 1/2 | 113PLN-4 x 1.5 | 7-113PLN-4 x 1.5 |
| 1/4 x 2 | 113PLN-4 x 2 | 7-113PLN-4 x 2 |
| 1/4 x 2 1/2 | 113PLN-4 x 2.5 | 7-113PLN-4 x 2.5 |
| 1/4 x 3 | 113PLN-4 x 3 | 7-113PLN-4 x 3 |
| 3/8 x 1 1/2 | 113PLN-6 x 1.5 | 7-113PLN-6 x 1.5 |
| 3/8 x 2 | 113PLN-6 x 2 | 7-113PLN-6 x 2 |



Hex Nipple

| Pipe Size | Brass Part # | Chrome Part # |
|-----------|--------------|---------------|
| 1/8 | 122PHN-2 | 7-122PHN-2 |
| 1/4 | 122PHN-4 | 7-122PHN-4 |
| 3/8 | 122PHN-6 | 7-122PHN-6 |



Hex Reducing Nipple

| Pipe Size | Brass Part # | Chrome Part # |
|-----------|--------------|----------------|
| 1/4 x 1/8 | 123PRN-4 x 2 | 7-123PRN-4 x 2 |
| 3/8 x 1/4 | 123PRN-6 x 4 | 7-123PRN-6 x 4 |



Adapter

| Pipe Size | Brass Part # | Chrome Part # |
|-----------|--------------|---------------|
| 1/8 x 1/8 | 120PA-2 x 2 | 7-120PA-2 x 2 |
| 1/4 x 1/8 | 120PA-4 x 2 | 7-120PA-4 x 2 |
| 1/4 x 1/4 | 120PA-4 x 4 | 7-120PA-4 x 4 |
| 3/8 x 1/4 | 120PA-6 x 4 | 7-120PA-6 x 4 |



Pipe and Inverted Flare Fittings



Pipe Bushing

| Pipe Size | Brass Part # | Chrome Part # |
|-----------|--------------|---------------|
| 1/4 x 1/8 | 110PB-4 x 2 | 7-110PB-4 x 2 |
| 3/8 x 1/8 | 110PB-6 x 2 | 7-110PB-6 x 2 |
| 3/8 x 1/4 | 110PB-6 x 4 | 7-110PB-6 x 4 |
| 1/2 x 1/4 | 110PB-8 x 4 | 7-110PB-8 x 4 |
| 1/2 x 3/8 | 110PB-8 x 6 | 7-110PB-8 x 6 |



Inverted Flare Fittings

Brass Inverted Flare Tube Nut

| O.D. Tube | Brass Part # | Chrome Part # |
|-----------|--------------|---------------|
| 3/16 | 411NB-3 | 7-411NB-3 |
| 1/4 | 411NB-4 | 7-411NB-4 |
| 5/16 | 411NB-5 | 7-411NB-5 |
| 3/8 | 411NB-6 | 7-411NB-6 |



Pipe Thread Lock Nut

| Pipe Size | Brass Part # | Chrome Part # |
|-----------|--------------|---------------|
| 1/8 | 111PLN-2 | 7-111PLN-2 |
| 1/4 | 111PLN-4 | 7-111PLN-4 |
| 3/8 | 111PLN-6 | 7-111PLN-6 |



Steel Inverted Flare Long Tube Nut

| O.D. Tube | Brass Part # | Chrome Part # |
|-----------|--------------|---------------|
| 3/16 | 411NL-3 | 7-411NL-3 |
| 1/4 | 411NL-4 | 7-411NL-4 |



Pipe Tee

| Pipe Size | Brass Part # | Chrome Part # |
|-----------|--------------|---------------|
| 1/8 | 101PT-2 | 7-101PT-2 |
| 1/4 | 101PT-4 | 7-101PT-4 |
| 3/8 | 101PT-6 | 7-101PT-6 |



Inverted Flare Male Connectors

| O.D. Tube | O.D. Pipe | Brass Part # | Chrome Part # |
|-----------|-----------|--------------|---------------|
| 3/16 | 1/8 | 48IC-3 x 2 | 7-48IC-3 x 2 |
| 1/4 | 1/8 | 48IC-4 x 2 | 7-48IC-4 x 2 |
| 5/16 | 1/8 | 48IC-5 x 2 | 7-48IC-5 x 2 |
| 5/16 | 1/4 | 48IC-5 x 4 | 7-48IC-5 x 4 |
| 3/8 | 1/8 | 48IC-6 x 2 | 7-48IC-6 x 2 |
| 3/8 | 1/4 | 48IC-6 x 4 | 7-48IC-6 x 4 |



Pipe Street Tee

| Pipe Size | Brass Part # | Chrome Part # |
|-----------|--------------|---------------|
| 1/8 | 127PT-2 | 7-127PT-2 |
| 1/4 | 127PT-4 | 7-127PT-4 |
| 3/8 | 127PT-6 | 7-127PT-6 |



Inverted Flare Male Elbow

| O.D. Tube | O.D. Pipe | Brass Part # | Chrome Part # |
|-----------|-----------|--------------|---------------|
| 3/16 | 1/8 | 49IE-3 x 2 | 7-49IE-3 x 2 |
| 1/4 | 1/8 | 49IE-4 x 2 | 7-49IE-4 x 2 |
| 5/16 | 1/8 | 49IE-5 x 2 | 7-49IE-5 x 2 |
| 5/16 | 1/4 | 49IE-5 x 4 | 7-49IE-5 x 4 |
| 3/8 | 1/8 | 49IE-6 x 2 | 7-49IE-6 x 2 |
| 3/8 | 1/4 | 49IE-6 x 4 | 7-49IE-6 x 4 |



Straight Heater Hose Barb

| Hose Size | Pipe Size | Brass Part # | Chrome Part # |
|-----------|-----------|--------------|----------------|
| 5/8 | 3/8 | 68HHB-10 x 6 | 7-68HHB-10 x 6 |
| 5/8 | 1/2 | 68HHB-10 x 8 | 7-68HHB-10 x 8 |
| 3/4 | 1/2 | 68HHB-12 x 8 | 7-68HHB-12 x 8 |
| 3/8 | 3/8 | 68HHB-6 x 6 | 7-68HHB-6 x 6 |
| 1/2 | 3/8 | 68HHB-8 x 6 | 7-68HHB-8 x 6 |



Inverted Male Rigid Hose Barb

| Hose Size | O.D. Tube | Brass Part # | Chrome Part # |
|-----------|-----------|--------------|---------------|
| 1/4 | 1/4 | 93HB-4 x 4 | 7-93HB-4 x 4 |
| 1/4 | 5/16 | 93HB-4 x 5 | 7-93HB-4 x 5 |
| 5/16 | 1/4 | 93HB-5 x 4 | 7-93HB-5 x 4 |
| 5/16 | 5/16 | 93HB-5 x 5 | 7-93HB-5 x 5 |
| 5/16 | 3/8 | 93HB-5 x 6 | 7-93HB-5 x 6 |
| 3/8 | 5/16 | 93HB-6 x 5 | 7-93HB-6 x 5 |



Extended Straight Heater Hose Barb

| Hose Size | Pipe Size | Chrome Part # |
|-----------|-----------|-----------------|
| 5/8 | 1/2 | 7-68HHBL-10 x 8 |



90° Heater Hose Barb

| Hose Size | Pipe Size | Brass Part # | Chrome Part # |
|-----------|-----------|--------------|----------------|
| 5/8 | 3/8 | 69HHB-10 x 6 | 7-69HHB-10 x 6 |
| 5/8 | 1/2 | 69HHB-10 x 8 | 7-69HHB-10 x 8 |
| 3/4 | 1/2 | 69HHB-12 x 8 | 7-69HHB-12 x 8 |
| 3/8 | 3/8 | 69HHB-6 x 6 | 7-69HHB-6 x 6 |
| 1/2 | 3/8 | 69HHB-8 x 6 | 7-69HHB-8 x 6 |



Inverted Flare Reducing Nut

| O.D. Tube | Inv. Nut | Brass Part # | Chrome Part # |
|-----------|----------|----------------|------------------|
| 3/16 | 1/4 | 411NR-3 x 4 | 7-411NR-3 x 4 |
| 3/16 | 5/16 | 411NR-3 x 5 | 7-411NR-3 x 5 |
| 3/16 | 9/16 | 411NR-3 x 9/16 | 7-411NR-3 x 9/16 |
| 1/4 | 9/16 | 411NR-4 x 9/16 | 7-411NR-4 x 9/16 |





Inverted and Special Fittings

Steel Inverted Flare Nut

| O.D. Tube | Brass Part # | Chrome Part # |
|-----------|--------------|---------------|
| 3/16 | 41INS-3 | 7-41INS-3 |
| 1/4 | 41INS-4 | 7-41INS-4 |
| 5/16 | 41INS-5 | 7-41INS-5 |
| 3/8 | 41INS-6 | 7-41INS-6 |



Inverted Flare Steel Plug

| O.D. Tube | Brass Part # | Chrome Part # |
|-----------|--------------|---------------|
| 3/16 | W131-3 | 7-W131-3 |
| 1/4 | W131-4 | 7-W131-4 |
| 5/16 | W131-5 | 7-W131-5 |
| 3/8 | W131-6 | 7-W131-6 |



Inverted Flare Union Tee

| O.D. Tube | Brass Part # | Chrome Part # |
|-----------|--------------|---------------|
| 3/16 | W702-3 | 7-W702-3 |
| 1/4 | W702-4 | 7-W702-4 |
| 5/16 | W702-5 | 7-W702-5 |

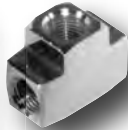

Inverted Flare Brake Line Union

| O.D. Tube | Brass Part # | Chrome Part # |
|-----------|--------------|---------------|
| 3/16 | 42IU-3 | 7-42IU-3 |
| 1/4 | 42IU-4 | 7-42IU-4 |
| 5/16 | 42IU-5 | 7-42IU-5 |
| 3/8 | 42IU-6 | 7-42IU-6 |



Brake Line Tee Mount Inverted Flare

| O.D. Tube | Brass Part # | Chrome Part # |
|-----------|--------------|---------------|
| 3/16 | W7812 | 7-W7812 |
| 1/4 | W7765 | 7-W7765 |

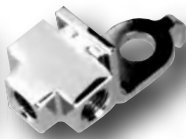

Metric Brake Line Adapter

| Inverted Female x Male Thread | Brass Part # | Chrome Part # |
|-------------------------------|--------------|---------------|
| 3/16 std 10mm x 1.0 | 202M-10 | 7-202M-10 |
| 10mm x 1.0 x 11mm x 1.5 | 202M-11 | 7-202M-11 |
| 10mm x 1.0 x 12mm x 1.0 | 202M-12 | 7-202M-12 |
| 10mm x 1.0 x 13mm x 1.5 | 202M-13 | 7-202M-13 |

Inverted Flare Male Branch Tee

| Size | Brass Part # | Chrome Part # |
|------|--------------|---------------|
| 3/16 | W600-3 x 2 | 7-W600-3 x 2 |
| 1/4 | W600-4 x 2 | 7-W600-4 x 2 |
| 5/16 | W600-5 x 2 | 7-W600-5 x 2 |
| 3/8 | W600-6 x 4 | 7-W600-6 x 4 |



Compression Fittings Brass

Compression Sleeve

| O.D. Tube | Part # |
|-----------|----------|
| 1/8 | 6460CS-2 |
| 3/16 | 6460CS-3 |
| 1/4 | 6460CS-4 |
| 5/16 | 6460CS-5 |
| 3/8 | 6460CS-6 |



Compression Nut

| O.D. Tube | Brass Part # | Chrome Part # |
|-----------|--------------|---------------|
| 1/8 | 61CN-2 | 7-61CN-2 |
| 3/16 | 61CN-3 | 7-61CN-3 |
| 1/4 | 61CN-4 | 7-61CN-4 |
| 5/16 | 61CN-5 | 7-61CN-5 |
| 3/8 | 61CN-6 | 7-61CN-6 |

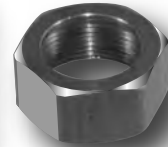

Compression Tube Inserts

| O.D. Tube | Part # |
|-----------|--------|
| 1/8 | 60TI-2 |
| 3/16 | 60TI-3 |
| 1/4 | 60TI-4 |
| 5/16 | 60TI-5 |
| 3/8 | 60TI-6 |



Compression Full Union

| O.D. Tube | Brass Part # | Chrome Part # |
|-----------|--------------|---------------|
| 1/8 | 62CU-2 | 7-62CU-2 |
| 3/16 | 62CU-3 | 7-62CU-3 |
| 1/4 | 62CU-4 | 7-62CU-4 |
| 5/16 | 62CU-5 | 7-62CU-5 |
| 3/8 | 62CU-6 | 7-62CU-6 |



Compression 3 Way Tee

| O.D. Tube | Brass Part # | Chrome Part # |
|-----------|--------------|---------------|
| 1/8 | 64CT-2 | 7-64CT-2 |
| 3/16 | 64CT-3 | 7-64CT-3 |
| 1/4 | 64CT-4 | 7-64CT-4 |
| 5/16 | 64CT-5 | 7-64CT-5 |
| 3/8 | 64CT-6 | 7-64CT-6 |





Compression Male Connector

| O.D. Tube | Brass Part # | Chrome Part # |
|------------|--------------|---------------|
| 1/8 x 1/8 | 68CC-2 x 2 | 7-68CC-2 x 2 |
| 3/16 x 1/8 | 68CC-3 x 2 | 7-68CC-3 x 2 |
| 1/4 x 1/8 | 68CC-4 x 2 | 7-68CC-4 x 2 |
| 1/4 x 1/4 | 68CC-4 x 4 | 7-68CC-4 x 4 |
| 5/16 x 1/8 | 68CC-5 x 2 | 7-68CC-5 x 2 |
| 5/16 x 1/4 | 68CC-5 x 4 | 7-68CC-5 x 4 |
| 3/8 x 1/8 | 68CC-6 x 2 | 7-68CC-6 x 2 |
| 3/8 x 1/4 | 68CC-6 x 4 | 7-68CC-6 x 4 |
| 3/8 x 3/8 | 68CC-6 x 6 | 7-68CC-6 x 6 |
| 1/2 x 1/4 | 68CC-8 x 4 | 7-68CC-8 x 4 |



Hose Tee

| Hose | Brass Part # | Chrome Part # |
|------|--------------|---------------|
| 1/4 | 94HBT-4 | 7-94HBT-4 |
| 5/16 | 94HBT-5 | 7-94HBT-5 |
| 3/8 | 94HBT-6 | 7-94HBT-6 |



Fittings

Compression Male Elbow

| O.D. Tube | Brass Part # | Chrome Part # |
|------------|--------------|---------------|
| 1/8 x 1/8 | 69CE-2 x 2 | 7-69CE-2 x 2 |
| 3/16 x 1/8 | 69CE-3 x 2 | 7-69CE-3 x 2 |
| 1/4 x 1/8 | 69CE-4 x 2 | 7-69CE-4 x 2 |
| 1/4 x 1/4 | 69CE-4 x 4 | 7-69CE-4 x 4 |
| 5/16 x 1/8 | 69CE-5 x 2 | 7-69CE-5 x 2 |
| 5/16 x 1/4 | 69CE-5 x 4 | 7-69CE-5 x 4 |
| 3/8 x 1/8 | 69CE-6 x 2 | 7-69CE-6 x 2 |
| 3/8 x 1/4 | 69CE-6 x 4 | 7-69CE-6 x 4 |
| 3/8 x 3/8 | 69CE-6 x 6 | 7-69CE-6 x 6 |



Transmission Adapter

| Inv. Flare Str. Pipe | Brass Part # | Chrome Part # |
|----------------------|--------------|---------------|
| 5/16 x 1/8 | | |



Special Fittings

Dual Brake Reducing Adapter

| Hose/Hose | Brass Part # | Chrome Part # |
|--------------------------------|--------------|---------------|
| 3/16 x 1/4 | 203-3 x 4 | 7-203-3 x 4 |
| 3/16 x 5/16 | 203-3 x 5 | 7-203-3 x 5 |
| 1/4 x 3/16 | 203-4 x 3 | 7-203-4 x 3 |
| 1/4 x 5/16 | 203-4 x 5 | 7-203-4 x 5 |
| 5/16 x 1/4 | 203-5 x 4 | 7-203-5 x 4 |
| 5/16 x 3/8 | 203-5 x 6 | 7-203-5 x 6 |
| 3/8 x 5/16 | 203-6 x 5 | 7-203-6 x 5 |
| 1/4 x 1/4 (9/16-18) | 203-7908 | 7-203-7908 |
| 3/16 x 3/16 (9/16-20) | 203-7910 | 7-203-7910 |
| 3/16 x 3/16 (9/16-18) | 203-7911 | 7-203-7911 |
| 3/16 (9/16-18) x 5/16 | 203-7912 | 7-203-7912 |
| 3/16 (1/2-20) x 3/16 (9/16-18) | 203-7913 | 7-203-7913 |
| 5/16 x 5/16 w/seal | 203F-1074 | 7-203F-1074 |
| 1/4 x 5/16 w/seal | 203F-7727 | 7-203F-7727 |
| 1/4 x 7/16-20 w/seal | 203F-7732 | 7-203F-7732 |
| 3/16 x 5/16 w/seal | 203F-7817 | 7-203F-7817 |



Metric Brake Union

| Thread/Flare | Brass Part # | Chrome Part # |
|---------------------|--------------|---------------|
| 3/16 Std/Bubble 3 | 300B-3 | 7-300B-3 |
| 10mm x 1.0 Standard | 300M-3 | 7-300M-3 |
| 10mm x 1.0 Bubble 2 | 300MB-3 | 7-300MB-3 |



Hose Splicer

| Hose/Hose | Brass Part # | Chrome Part # |
|-------------|--------------|---------------|
| 3/16 x 3/16 | 92HB-3 x 3 | 7-92HB-3 x 3 |
| 1/4 x 1/4 | 92HB-4 x 4 | 7-92HB-4 x 4 |
| 5/16 x 5/16 | 92HB-5 x 5 | 7-92HB-5 x 5 |
| 3/8 x 3/8 | 92HB-6 x 6 | 7-92HB-6 x 6 |





Chrome and Brass Fittings

Drain Cocks

| Size | Brass # | Chrome # |
|------|---------|-----------|
| 1/4 | 326DC-4 | 7-326DC-4 |



Brake Bleeder Screws Chrome

| Size | Part # |
|-------------------|---------|
| 3/8-24 x 1 1/2 | 45-9400 |
| 3/8-24 x 1 1/8 | 45-9402 |
| 5/16-24 x 1 | 45-9403 |
| 1/4-28 x 1 | 45-9404 |
| 8mm x 1.25 x 23.8 | 45-9405 |
| 10mm x 1.5 x 27.5 | 45-9406 |



Grease Fittings

| Size | Part # |
|------------------------|---------|
| 1/4-28 45° (Chrome) | 57546 |
| 1/4-28 Straight | 57547 |
| 1/4-28 Straight-Long | 57547-L |
| 1/4-28 90° | 57548 |
| 1/8 45° | 57549 |
| 1/8 Straight | 57550 |
| 1/8 90° | 57551 |
| 1/4-28 90° (Stainless) | 88546 |
| 1/4-28 Straight | 88547 |
| 1/8 Straight | 88610 |
| 1/8 90° | 88613 |
| 1/8 45° | 88688 |



Steel Brake Line Coil

| Size | Part # |
|------|--------|
| 3/16 | 64542 |
| 1/4 | 64546 |
| 5/16 | 64548 |
| 3/8 | 64550 |



Vacuum Connectors

Vacuum Hose Splicer Plastic

| Hose/Hose | Part # |
|-------------|-------------|
| 1/8 x 1/8 | 62NU-2 |
| 3/16 x 3/16 | 62NU-3 |
| 1/4 x 1/4 | 62NU-4 |
| 5/16 x 5/16 | 62NU-5 |
| 3/8 x 3/8 | 62NU-6 |
| 3/16 x 1/8 | 62NUR-3 x 2 |
| 3/16 x 1/4 | 62NUR-3 x 4 |
| 1/4 x 1/8 | 62NUR-4 x 2 |
| 1/4 x 3/8 | 62NUR-4 x 6 |



Vacuum Hose Elbow Plastic

| Hose/Hose | Part # |
|-------------|------------|
| 3/16 x 3/16 | 64NE-3 |
| 3/16 x 1/8 | 64NE-3 x 2 |
| 3/16 x 1/4 | 64NE-3 x 4 |
| 1/4 x 1/4 | 64NE-4 |



Vacuum Hose Tee Plastic

| Hose/Hose | Part # |
|-------------------|----------------|
| 1/8 | 64NT-2 |
| 3/32 | 64NT-2.5 |
| 1/8 x 3/16 x 1/8 | 64NT-2 x 3 x 2 |
| 3/16 | 64NT-3 |
| 3/16 x 1/8 x 3/16 | 64NT-3 x 2 x 3 |
| 3/16 x 3/16 x 1/8 | 64NT-3 x 3 x 2 |
| 3/16 x 1/4 x 3/16 | 64NT-3 x 4 x 3 |
| 1/4 | 64NT-4 |
| 1/4 x 1/4 x 3/16 | 64NT-4 x 4 x 3 |
| 5/16 | 64NT-5 |
| 3/8 | 64NT-6 |
| 3/8 x 3/8 x 1/4 | 64NT-6 x 6 x 4 |



Vacuum Rubber Caps

| I.D.Hose | Part # |
|----------|-----------|
| 1/8 | 64CAP-2 |
| 5/32 | 64CAP-2.5 |
| 3/16 | 64CAP-3 |
| 1/4 | 64CAP-4 |
| 5/16 | 64CAP-5 |
| 3/8 | 64CAP-6 |





Inside This Section

Detail Listing on each Unit

| | |
|---|----|
| J1POP-1 Hex Caps and Hex Nuts (Chrome Plated)..... | 76 |
| J1POP-2 Washers, Body Bolts and Pipe Plugs (Chrome Plated)..... | 76 |
| J1POP-3 Oval Phillips, Slotted Machine and Sheet Metal Screws (Chrome Plated)..... | 77 |
| J1POP-4 Button Head, Carriage Bolts and Lock Nuts (Chromed Plated)..... | 77 |
| J1POP-5 Brass Fittings Hand Polished (Chrome Plated)..... | 78 |
| LOGO DISPLAYERS Counter Top Unit with Stamped Hex Caps..... | 78 |
| J1POP-6 Ford and Chrysler Mopar Bolt Kits (Chrome & Polished Stainless)..... | 79 |
| J1POP-7 Chevy Kits and Bowtie Stamped Bolts..... | 80 |
| J1POP-8 Chevy Bowtie and Ford Oval Stamped Bolts Kits..... | 81 |
| J1POP-9 Chevy, Ford and Mopar Kits..... | 82 |
| J1POP-10 Metric Screw Kits (Chrome Plated)..... | 83 |
| J1POP-11 Ford Oval Stamped Bolt Kits (Chrome Plated & Polished Stainless)..... | 84 |
| J1POP-12 Metric Screw Kits (Stainless Steel)..... | 85 |
| J1POP-14 Ford & Ford Oval Stamped Bolt Kits (Chrome Plated)..... | 86 |
| J1POP-15 Ford Oval Stamped Bolt Kits (Chrome Plated)..... | 86 |
| J1POP-16 Pontiac Arrow Stamped Bolt Kits (Chrome Plated)..... | 87 |
| J2POP-1 Combination of J1POP-1 & J1POP-2 Units (Chrome Plated)..... | 88 |
| J2POP-2 Combination of J1POP-3 & J1POP-4 Units (Chrome Plated)..... | 89 |
| J2POP-3 Nuts, Washers, Button Heads, Hex Caps, Lock Nuts & Sheet Metal Screws (Polished Stainless)..... | 90 |

Product Display Units

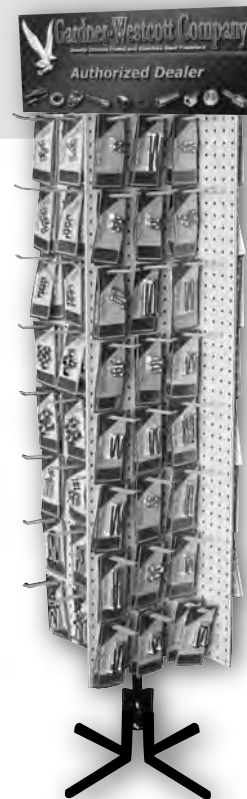

Hex Caps and Hex Nuts
Chrome Plated
#J1POP-1 Full Floor Unit



Brass Fittings Chrome Plated
#J1POP-5 Counter Top Unit



Logo Stamped
Counter Top Display Unit

What a simple way to organized and showcase your chrome plated and stainless steel fastener products.

- **Increases product visibility.**
- **Contains the most popular sizes sought after by auto enthusiasts.**
- **Allows wider range of product in least amount of space.**
- **Simple to stock and reorder.**
- **Customizing available to fit your needs.**



P.O.P. Unit Descriptions

COUNTER TOP UNITS



J1POP-1 Hex Caps & Hex Nuts - contains (48) items in chrome and (2) ea. carded kits of the following fasteners:

| Kit Part # | Description | Qty. per card | Kit Part # | Description | Qty. per card | Kit Part # | Description | Qty. per card |
|------------|----------------------------|---------------|------------|----------------------------|---------------|------------|--------------------|---------------|
| J0012 | - 1/4-20 x 1/2 Hex Caps | (4) | J0108 | - 3/8-16 x 1 1/2 Hex Caps | (4) | J0765 | - 10/24 Hex Nuts | (12) |
| J0016 | - 1/4-20 x 3/4 Hex Caps | (4) | J0110 | - 3/8-16 x 1 3/4 Hex Caps | (4) | J0766 | - 10/32 Hex Nuts | (12) |
| J0020 | - 1/4-20 x 1 Hex Caps | (4) | J0112 | - 3/8-16 x 2 Hex Caps | (4) | J0768 | - 1/4-20 Hex Nuts | (15) |
| J0050 | - 5/16-18 x 5/8 Hex Caps | (4) | J0114 | - 3/8-16 x 2 1/4 Hex Caps | (4) | J0769 | - 1/4-28 Hex Nuts | (15) |
| J0052 | - 5/16-18 x 3/4 Hex Caps | (4) | J0116 | - 3/8-16 x 2 1/2 Hex Caps | (4) | J0770 | - 5/16-18 Hex Nuts | (13) |
| J0053 | - 5/16-24 x 3/4 Hex Caps | (4) | J0118 | - 3/8-16 x 2 3/4 Hex Caps | (3) | J0771 | - 5/24-24 Hex Nuts | (13) |
| J0056 | - 5/16-18 x 1 Hex Caps | (4) | J0120 | - 3/8-16 x 3 Hex Caps | (3) | J0772 | - 3/8-16 Hex Nuts | (11) |
| J0059 | - 5/16-18 x 1 1/4 Hex Caps | (4) | J0148 | - 7/16-14 x 1 Hex Caps | (3) | J0773 | - 3/8-24 Hex Nuts | (11) |
| J0065 | - 5/16-18 x 2 Hex Caps | (4) | J0150 | - 7/16-14 x 1 1/4 Hex Caps | (3) | J0774 | - 7/16-14 Hex Nuts | (7) |
| J0068 | - 5/16-24 x 2 1/4 Hex Caps | (4) | J0156 | - 7/16-14 x 2 Hex Caps | (3) | J0775 | - 7/16-20 Hex Nuts | (7) |
| J0069 | - 5/16-18 x 2 1/2 Hex Caps | (4) | J0184 | - 1/2-13 x 1 Hex Caps | (3) | J0776 | - 1/2-13 Hex Nuts | (6) |
| J0098 | - 3/8-16 x 3/4 Hex Caps | (4) | J0188 | - 1/2-13 x 1 1/2 Hex Caps | (3) | J0777 | - 1/2-20 Hex Nuts | (6) |
| J0099 | - 3/8-24 x 3/4 Hex Caps | (4) | J0189 | - 1/2-20 x 1 1/2 Hex Caps | (3) | J0778 | - 9/16-12 Hex Nuts | (5) |
| J0102 | - 3/8-16 x 1 Hex Caps | (4) | J0192 | - 1/2-13 x 2 Hex Caps | (3) | J0779 | - 9/16-18 Hex Nuts | (5) |
| J0103 | - 3/8-24 x 1 Hex Caps | (4) | J0196 | - 1/2-13 x 2 1/2 Hex Caps | (3) | J0780 | - 5/8-11 Hex Nuts | (5) |
| J0106 | - 3/8-16 x 1 1/4 Hex Caps | (4) | J0197 | - 1/2-20 x 2 1/2 Hex Caps | (3) | J0781 | - 5/8-18 Hex Nuts | (5) |

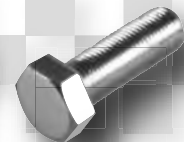

J1POP-2 Washers, Body Bolts & Pipe Plugs - contains (48) Items in chrome and (2) ea. carded kits of the following:

| Kit Part # | Description | Qty. per card | Kit Part # | Description | Qty. per card | Kit Part # | Description | Qty. per card |
|------------|---------------------|---------------|------------|-----------------------------------|---------------|------------|--------------------------------|---------------|
| J0852 | - #10 Flat Washers | (14) | J0876 | - 5/16 AN Washers | (11) | J2229 | - 5/16 x 13/16 Pol. Body Bolts | (4) |
| J0854 | - 1/4 Flat Washers | (15) | J0877 | - 3/8 AN Washers | (10) | J2230 | - 5/16 x 1 1/4 Pol. Body Bolts | (3) |
| J0855 | - 5/16 Flat Washers | (13) | J0878 | - 7/16 AN Washers | (8) | J2255 | - 1/4-20 x 7/8 Hex Sems | (4) |
| J0856 | - 3/8 Flat Washers | (11) | J0879 | - 1/2 AN Washers | (7) | J2256 | - 5/16-18 x 1 Hex Sems | (4) |
| J0857 | - 7/16 Flat Washers | (10) | J0880 | - 9/16 AN Washers | (6) | J2257 | - 3/8-16 x 3/4 Hex Sems | (3) |
| J0858 | - 1/2 Flat Washers | (9) | J0881 | - 5/8 AN Washers | (6) | J2258 | - 3/8-16 x 1 Hex Sems | (3) |
| J0859 | - 9/16 Flat Washers | (8) | J2250 | - 3/8 x 1 1/4 Shock Washers | (4) | J2259 | - 3/8-16 1 1/2 Hex Sems | (3) |
| J0860 | - 5/8 Flat Washers | (8) | J2251 | - 1/2 x 1 1/4 Shock Washers | (4) | J2261 | - 1/4-20 x 5/8 Spin Locks | (6) |
| J0865 | - 1/4 Lock Washers | (15) | J2252 | - 1/2 x 1 7/16 Shock Washers | (4) | J2262 | - 5/16-18 x 3/4 Spinlocks | (4) |
| J0866 | - 5/16 Lock Washers | (13) | J2253 | - 5/8 x 1 1/4 Shock Washers | (4) | J2263 | - 5/16-18 x 1 Spinlocks | (4) |
| J0867 | - 3/8 Lock Washers | (11) | J2223 | - 5/16-18 x1 SS Body Bolts | (1) | J2264 | - 5/16-18 X 1 1/4 Spinlocks | (4) |
| J0868 | - 7/16 Lock Washers | (10) | J2224 | - 14 x 3/4 Body Bolts 3/8 AF | (10) | J2265 | - 3/8-16 x 1 Spinlocks | (3) |
| J0869 | - 1/2 Lock Washers | (9) | J2225 | - 14 x 3/4 Pol. Body Bolts 3/8 AF | (9) | J2266 | - 5/16-24 x 1 Spinlocks | (5) |
| J0870 | - 9/16 Lock Washers | (8) | J2226 | - 14 x 3/4 Body Bolts 7/16 AF | (9) | J2267 | - 3/8 Pipe Plugs | (3) |
| J0871 | - 5/8 Lock Washers | (8) | J2227 | - 5/16 x 13/16 Body Bolts | (7) | J2268 | - 1/2 Pipe Plugs | (2) |
| J0875 | - 1/4 AN Washers | (12) | J2228 | - 5/16 x 1 1/4 Body Bolts | (4) | J2269 | - 3/4 Pipe Plugs | (2) |





P.O.P Unit Descriptions



COUNTER TOP UNITS

J1POP-3 Oval Slotted & Phillips Machine Screws - contains (48) items in chrome and (2) ea. carded kits of the following fasteners:

| Kit Part # | Description | Qty. per card | Kit Part # | Description | Qty. per card | Kit Part # | Description | Qty. per card |
|------------|------------------------------|---------------|------------|-------------------------------|---------------|------------|------------------------------------|---------------|
| J0982 | - 6/32 x 3/8 Oval Slot MS | (5) | J1020 | - 12/24 x 1 Oval Slot MS | (4) | J1298 | - 8 x 3/4 Oval Phillips SMS | (6) |
| J0983 | - 6/32 x 1/2 Oval. Sl. MS | (5) | J1025 | - 1/4-20 x 1 Oval. Sl. MS | (6) | J1299 | - 8 x 3/4 Oval. Ph. # 6 Hds. SMS | (6) |
| J0985 | - 6/32 x 3/4 Oval. Sl. MS | (5) | J1036 | - 5/16-24 x 1 Oval. Sl. MS | (5) | J1300 | - 8 x 7/8 Oval. Ph. SMS | (6) |
| J0986 | - 6/32 x 1 Oval. Sl. MS | (5) | J1157 | - 10/32 x 3/8 Oval. Ph. MS | (6) | J1301 | - 8 x 7/8 Oval. Ph. # 6 Hds. SMS | (6) |
| J0992 | - 8/32 x 1/2 Oval. Sl. MS | (7) | J1159 | - 10/32 x 1/2 Oval. Ph. MS | (6) | J1302 | - 8 x 1 Oval. Ph. SMS | (6) |
| J1001 | - 10/24 x 1/2 Oval. Sl. MS | (6) | J1162 | - 10/24 x 3/4 Oval. Ph. MS | (6) | J1303 | - 8 x 1 Oval. Ph. # 6 Hds. SMS | (6) |
| J1002 | - 10/32 x 1/2 Oval. Sl. MS | (6) | J1163 | - 10/32 x 3/4 Oval. Ph. MS | (6) | J1304 | - 8 x 1 1/4 Oval. Ph. SMS | (6) |
| J1005 | - 10/24 x 3/4 Oval. Sl. MS | (6) | J1166 | - 10/24 x 1 Oval. Ph. MS | (6) | J1305 | - 8 x 1 1/4 Oval. Ph. # 6 Hds. SMS | (5) |
| J1006 | - 10/32 x 3/4 Oval. Sl. MS | (6) | J1167 | - 10/32 x 1 Oval. Ph. MS | (6) | J1306 | - 8 x 1 1/2 Oval. Ph. SMS | (5) |
| J1008 | - 10/32 x 1 Oval. Sl. MS | (6) | J1182 | - 1/4-20 x 3/4 Oval. Ph. MS | (6) | J1307 | - 8 x 1 1/2 Oval. Ph. # 6 Hds. SMS | (5) |
| J1010 | - 10/32 x 1 1/4 Oval. Sl. MS | (4) | J1183 | - 1/4-20 x 1 Oval. Ph. MS | (6) | J1308 | - 8 x 3/4 Oval. Ph. # 6 Hds. SMS | (4) |
| J1012 | - 10/32 x 1 1/2 Oval. Sl. MS | (4) | J1186 | - 1/4-20 x 1 1/2 Oval. Ph. MS | (6) | J1309 | - 8 x 3/4 Oval. Ph. SMS | (6) |
| J1013 | - 10/32 x 1 3/4 Oval. Sl. MS | (4) | J1294 | - 8 x 1/2 Oval. Ph. SMS | (6) | J1310 | - 8 x 2 Oval. Ph. SMS | (5) |
| J1014 | - 10/32 x 2 Oval. Sl. MS | (4) | J1295 | - 8 x 1/2 Oval. Ph. HD SMS | (6) | J1311 | - 8 x 2 Oval. Ph. # 6 Hds. SMS | (4) |
| J1017 | - 12/24 x 1/2 Oval. Sl. MS | (4) | J1296 | - 8 x 5/8 Oval. Ph. SMS | (6) | J1315 | - 10 x 3/4 Oval. Ph. SMS | (7) |
| J1019 | - 12/24 x 3/4 Oval Sl. MS | (4) | J1297 | - 8 x 5/8 Oval. Ph. #6 Hds. | (6) | J1317 | - 12 x 1 Oval. Ph. SMS | (4) |

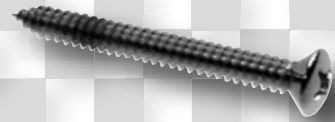

J1POP-4 Button Heads, Carriage Bolts & Super Washers - contains (48) items in chrome and (2) ea. carded kits of the following:

| Kit Part # | Description | Qty. per card | Kit Part # | Description | Qty. per card | Kit Part # | Description | Qty. per card |
|------------|-----------------------------|---------------|------------|----------------------------|---------------|------------|------------------------------------|---------------|
| J0535 | - 8/32 x 1/2 Button Heads | (4) | J0618 | - 3/8-16 x 1 1/2 Btn. Hds. | (2) | J0891 | - 1/4 x 1 1/2 Carriage Bolts w/HN | (4) |
| J0546 | - 10/24 x 1/2 Btn. Hds. | (4) | J0793 | - 1/4-20 Lock Nuts | (8) | J0901 | - 5/16 x 1 Carriage Bolts w/HN | (4) |
| J0547 | - 10/32 x 1/2 Btn. Hds. | (4) | J0794 | - 1/4-28 Lock Nuts | (8) | J0903 | - 5/16 x 1 1/2 Carriage Bolts w/HN | (4) |
| J0550 | - 10/24 x 3/4 Btn. Hds. | (4) | J0795 | - 5/16-18 Lock Nuts | (8) | J0914 | - 3/8-16 x 1 Carriage Bolts w/HN | (4) |
| J0551 | - 10/32 x 3/4 Btn. Hds. | (4) | J0796 | - 5/16-24 Lock Nuts | (8) | J0917 | - 3/8-16 x 2 Carriage Bolts w/HN | (4) |
| J0564 | - 1/4-20 x 1/2 Btn. Hds. | (4) | J0797 | - 3/8-16 Lock Nuts | (6) | J0918 | - 3/8 x 2 1/2 Carriage Bolts w/HN | (3) |
| J0568 | - 1/4-20 x 3/4 Btn. Hds. | (4) | J0798 | - 3/8-24 Lock Nuts | (6) | J0926 | - 7/16-14 x 1 1/4 Cge. Bolts w/HN | (3) |
| J0572 | - 1/4-20 x 1 Btn. Hds. | (4) | J0799 | - 7/16-14 Lock Nuts | (5) | J0928 | - 7/16-14 x 1 3/4 Cge. Bolts w/HN | (3) |
| J0574 | - 1/4-20 x 1 1/4 Btn. Hds. | (4) | J0800 | - 7/16-20 Lock Nuts | (5) | J0938 | - 1/2-13 x 1 3/4 Cge. Bolts w/HN | (3) |
| J0588 | - 5/16-18 x 3/4 Btn. Hds. | (4) | J0801 | - 1/2-13 Lock Nuts | (5) | J2271 | - 3/16 x 1 Super Washers | (5) |
| J0589 | - 5/16-24 x 3/4 Btn. Hds. | (4) | J0802 | - 1/2-20 Lock Nuts | (5) | J2272 | - 1/4 x 1 Super Washers | (5) |
| J0592 | - 5/16-18 x 1 Btn. Hds. | (4) | J0803 | - 9/16-12 Lock Nuts | (4) | J2273 | - 5/16 x 1 1/8 Super Washers | (5) |
| J0593 | - 5/16-24 x 1 Btn. Hds. | (4) | J0804 | - 9/16-18 Lock Nuts | (4) | J2274 | - 5/16 x 1 1/2 Super Washers | (4) |
| J0596 | - 5/16-18 x 1 1/2 Btn. Hds. | (3) | J0805 | - 5/8-11 Lock Nuts | (4) | J2275 | - 3/8 x 1 1/2 Super Washers | (4) |
| J0610 | - 3/8-16 x 3/4 Btn. Hds. | (4) | J0806 | - 5/16-16 Lock Nuts | (4) | J2276 | - 7/16 x 1 Super Washers | (6) |
| J0614 | - 3/8-16 x 1 Btn. Hds. | (4) | J0888 | - 1/4 x 3/4 Carriage w/HN | (4) | J2277 | - 1/2 x 1 1/4 Super Washers | (6) |

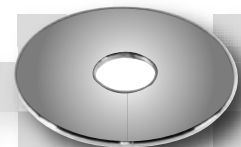



P.O.P. Unit Descriptions

COUNTER TOP UNITS



J1POP-5 Polished Brass Fittings Show Chrome Plated -

contains (47) items in chrome and (3) ea. carded kits of the following fasteners:

Gardner-Westcott took the standard brass fitting and hand polished it to a smooth mirror finish, than we Show Chrome Plated it. We then carded our hottest selling parts to create this counter top display unit. This turnable display unit contains 3 each of 47 different carded skin packed items.

Heater Hose Barb 90°

- J9001 5/8" Hose 1/2" Pipe (3)
- J9002 5/8" Hose 3/8" Pipe (3)

Heater Hose Barb Straight

- J9003 5/8" Hose 1/2" Pipe (3)
- J9004 5/8" Hose 3/8" Pipe (3)
- J9005 3/4" Hose 1/2" Pipe (3)

Hex Head Pipe Plugs

- J9006 1/2" (3)
- J9007 3/8" (3)
- J9008 1/4" (3)
- J9009 1/8" (3)

Inverted Flare Fittings

- J9010 3/16" Tube 1/8" Pipe 45° Male Elbow (3)
- J9011 3/16" x 1/4" Reducing Nut (3)
- J9023 1/8" Tube Nut Steel (3)
- J9024 Brake Line Union 3/16" (3) □
- J9040 3/16" Flare 1/8" Pipe Male Connector (3)
- J9041 3/16" x 1/8" Inv. Flare Female Branch Tee (3)

Transmission Adapter

- J9012 5/16" x 5/16" Inv. Flare Trans. Adapter (3)
- J9013 3/8" x 3/8" Inv. Nut Trans. Adapter (3)

Socket Pipe Plugs

- J9014 1/8" Socket Pipe Plugs (3)
- J9015 1/4" Socket Pipe Plugs (3)
- J9016 3/8" Socket Pipe Plugs (3)
- J9017 1/2" Socket Pipe Plugs (3)

Pipe Bushing

- J9018 1/4" x 1/8" (3)
- J9019 3/8" x 1/8" (3)
- J9020 3/8" x 1/4" (3)

Street Elbow Fittings

- J9021 1/8" (3)
- J9022 1/4" (3)



Counter Top
Display Unit



Part # J1POP-5
Hand Polished Brass Fittings
Show Chrome Plated
Contains (3) each carded of 47 Items

Adapter

- J9025 1/8" x 1/8" Adapter (3)

Straight Hose Barb - Male Pipe

- J9026 3/16" Hose 1/8" Pipe M.H.B.P. (3)
- J9027 1/4" Hose 1/8" Pipe M.H.B.P. (3)
- J9028 5/16" Hose 1/8" Pipe M.H.B.P. (3)
- J9029 3/8" Hose 1/8" Pipe M.H.B.P. (3)
- J9030 3/8" Hose 1/4" Pipe M.H.B.P. (3)

90° Hose Barb - Male Pipe

- J9031 5/16" Hose 1/8" Pipe 90° (3)
- J9032 3/8" Hose 1/8" Pipe 90° (3)
- J9033 3/8" Hose 1/4" Pipe 90° (3)

Brake Line Tee and Union

- J9034 3/16" Brake Line Tee w/Mount (3)
- J9035 3/16" Inv. Flare Union Tee (3)

Nipple

- J9036 1/8" Close Nipple (3)
- J9037 1/8" x 1 1/2" Long Nipple (3)

Drain Cock

- J9038 1/4" Drain Cocks (3)

Male Pipe Rigid Straight Hose Barb

- J9043 1/8" Hose 1/8" Pipe (3)
- J9044 1/4" Hose 1/8" Pipe (3)
- J9045 3/8" Hose 1/4" Pipe (3)

Brake Bleeder Screws

- J9046 3/8"-24 x 1 1/2" (3)
- J9047 3/8"-24 x 1 1/4" (3)
- J9048 5/16"-24 x 1" (3)
- J9049 1/4"-28 x 1" (3)

Logo Displayer Counter Top Unit

Gardner-Westcott also has a great way to showcase our very popular line of emblem stamped hex caps. Now your customers can see first hand the exceptional quality of each hand stamped emblem displayed on a green plastic stand that measures 7" high x 7" wide with a 3" base and can be placed in a highly visible area on your counter top. Each logo hex cap is identified with white letters clearly showing the Chevy Bowtie, Chevy SS, Chevy RS, Pontiac, Pontiac GT, Pontiac GTO, 350, 454, Oldsmobile Rocket, Chrysler Pentastar, Chrysler Mopar, Hemi Mopar, Dodge Ram, Ford Oval, Ford Vintage V-8, Mustang Pony, Flame and Skull. And we have added a few head styles to round out the display like Hex Caps Chrome Plated, Hex Caps Polished Stainless Steel, Allen Head Chrome Plated, Allen Head Stainless Steel Polished, 12 Point Chrome Plated, Button Head Allen Chrome Plated, Torx Button Head Chrome Plated and Flat Head Allen Chrome Plated.



Logo Display Counter Top Unit
Chrome Plated and Polished
Stainless Steel Fasteners
Part # Logo Display

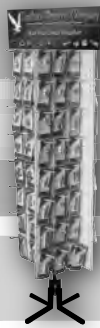

P.O.P Unit Descriptions



79

FULL FLOOR UNITS

J1POP-6 Ford and Mopar Engine Dress up kits - contains (80) items in chrome and polished stainless steel (1) & (2) ea. carded kits of the following kits:



Ford Chrome Hex Cap Kits

| Kit Part # | Description | Qty. of cards |
|------------|-------------------------------------|---------------|
| 56255-H | - 351 Cleveland Engine Dress Up Kit | (1) |
| 56250-H | - S/B Engine Dress Up Kit | (1) |
| 56248-H | - 302 Exhaust Manifold Kit | (2) |
| 56246-H | - 429 Intake Manifold Kit | (2) |
| 56244-H | - 390 Timing Cover Kit | (2) |
| 56242-H | - 289 Timing Cover Kit | (2) |
| 56243-H | - 351 Cleveland Fuel Pump Kit | (2) |
| 56240-H | - 289, 302 Fuel Pump Kit | (2) |
| 56236-H | - 700-R4 Trans Pan (1986) Kit | (2) |
| 56235-H | - C-4 Transmission Kit | (2) |
| 56234-H | - C-6 Trans Pan Kit | (2) |
| 56232-H | - 351 Cleveland & 400 Oil Pan Kit | (2) |
| 56231-H | - 289, 302 Oil Pan Kit | (2) |
| 56230-H | - Water Neck Kit | (2) |
| 56227-H | - 289 Aluminum Valve Cover Kit | (2) |
| 56226-H | - 428 Steel Valve Cover Kit | (2) |
| 56225-H | - 400 Steel Valve Cover Kit | (2) |
| 56224-H | - 289 Steel Valve Cover Kit | (2) |
| 56223-H | - 7/16 Header Bolts Kit | (2) |
| 56222-H | - 351 Cleveland Intake Manifold Kit | (2) |
| 56221-H | - 289 Intake Manifold Kit | (2) |

Ford Stainless Steel Hex Cap Kits

| Kit Part # | Description | Qty. of cards |
|------------|-------------------------------------|---------------|
| 56255-HSP | - 351 Cleveland Engine Dress Up Kit | (1) |
| 56250-HSP | - S/B Engine Dress Up Kit | (1) |
| 56248-HSP | - 302 Exhaust Manifold Kit | (2) |
| 56246-HSP | - 429 Intake Manifold Kit | (2) |
| 56244-HSP | - 390 Timing Cover Kit | (2) |
| 56242-HSP | - 289 Timing Cover Kit | (2) |
| 56243-HSP | - 351 Cleveland Fuel Pump Kit | (2) |
| 56240-HSP | - 289, 302 Fuel Pump Kit | (2) |
| 56236-HSP | - 700-R4 Trans Pan (1986) Kit | (2) |
| 56235-HSP | - C-4 Transmission Kit | (2) |
| 56234-HSP | - C-6 Trans Pan Kit | (2) |
| 56232-HSP | - 351 Cleveland & 400 Oil Pan Kit | (2) |
| 56231-HSP | - 289, 302 Oil Pan Kit | (2) |
| 56230-HSP | - Water Neck Kit | (2) |
| 56227-HSP | - 289 Aluminum Valve Cover Kit | (2) |
| 56226-HSP | - 428 Steel Valve Cover Kit | (2) |
| 56225-HSP | - 400 Steel Valve Cover Kit | (2) |
| 56224-HSP | - 289 Steel Valve Cover Kit | (2) |
| 56223-HSP | - 7/16 Header Bolts Kit | (2) |
| 56222-HSP | - 351 Cleveland Intake Manifold Kit | (2) |
| 56221-HSP | - 289 Intake Manifold Kit | (2) |



OFFICIAL LICENSED PRODUCT

MOPAR, JEEP, DODGE, HEMI, PLYMOUTH, RAM, SRT, CHRYSLER and related logos, vehicle model names and trade dress are trademarks of Chrysler Group LLC and used under license by (licensee name). ©2015 Chrysler Group LLC

Mopar Chrome Hex Cap Kits

| Kit Part # | Description | Qty. of cards |
|-------------|----------------------------------|---------------|
| 56332-H | - B/B Engine Dress Up Kit | (1) |
| 56330-H | - S/B Engine Dress Up Kit | (1) |
| 56306-H | - B/B Fuel Pump Kit | (2) |
| 56305-H | - S/B Water Pump Kit | (2) |
| 56304-H | - S/B Valve Cover Kit | (2) |
| 56303-H | - S/B Header Bolt Kit | (2) |
| 56302-H | - S/B Intake Manifold Kit | (2) |
| 56301-H | - S/B Oil Pan Kit | (2) |
| 09012 | - Chrome Throttle Return Spring | (2) |
| 09012 - Blu | - Blue Throttle Return Spring | (2) |
| 09015 | - Gold Throttle Return Spring | (2) |
| P-31-100 | - Ch. Valve Stem Covers | (2) |
| 56220-B | - Ch. Bullet License Plate Kit | (2) |
| 4083 | - Ch. 5/16 x 1 3/8 Carb Stud Kit | (2) |
| 4084 | - Ch. 5/16 x 1 1/2 Carb Stud Kit | (2) |
| 57605-C | - Interior Trim 4 Dr. Screw Kit | (2) |
| 57602-C | - Interior Trim 2 Dr. Screw Kit | (2) |
| J9001 | - 90° Heater Hose 5/8 x 1/2 | (2) |
| J9002 | - 90° Heater Hose 5/8 x 3/8 | (2) |

Mopar Stainless Steel Hex Cap Kits

| Kit Part # | Description | Qty. of cards |
|------------|----------------------------------|---------------|
| 56332-HSP | - B/B Engine Dress Up Kit | (1) |
| 56330-HSP | - S/B Engine Dress Up Kit | (1) |
| 56306-HSP | - B/B Fuel Pump Kit | (2) |
| 56305-HSP | - S/B Water Pump Kit | (2) |
| 56304-HSP | - S/B Valve Cover Kit | (2) |
| 56303-HSP | - S/B Header Bolt Kit | (2) |
| 56302-HSP | - S/B Intake Manifold Kit | (2) |
| 56301-HSP | - S/B Oil Pan Kit | (2) |
| 09012-Re | - Red Throttle Return Spring | (2) |
| 09012-BLK | - Black Throttle Return Spring | (2) |
| 67561-L | - 11/16-18 Left Hand Jam Nuts | (2) |
| 67561-R | - 11/16-18 Right Hand Jam Nuts | (2) |
| 4086 | - SS. 5/16 x 1 3/8 Carb Stud Kit | (2) |
| 4087 | - SS. 5/16 x 1 1/2 Carb Stud Kit | (2) |
| J9003 | - 5/8 x 1/2 Straight Heater Hose | (2) |
| J9004 | - 5/8 x 3/8 Straight Heater Hose | (2) |
| J9005 | - 3/4 x 1/2 Straight Heater Hose | (2) |
| J9038 | - 1/4 Drain Cocks | (2) |



P.O.P. Unit Descriptions

FULL FLOOR UNITS

J1POP-7 Chevy Engine Dress Up Application - contains (98) items in chrome and polished stainless steel (1) & (2) ea. carded kits of the following:



Exclusively From *Gardner-Westcott*

Make a Chevy Statement with Gardner-Westcott's very popular Chevy Bow Tie Bolts, The emblem is stamped directly onto the head of the bolts. Available in our Show Chrome Plated version or Polished Stainless Steel.



Chrome Plated Hex Cap Kits

| Kit Part # | Description | Qty. of cards |
|------------|--|---------------|
| 56490-H | - S/B Chevy Engine Dress Up Kit | (1) |
| 56465-H | - Oil Pan Bolts S/B & LT-1 Kit | (1) |
| 56485-H | - Steel Valve Covers B/B Kit | (1) |
| 56468-H | - Water Pump S/B Short Kit | (1) |
| 56464-H | - Timing Cover Kit | (1) |
| 56484-H | - Bell Housing Kit | (1) |
| 4083 | - 5/16 x 1 3/8 Carb Stud Kit | (1) |
| 4084 | - 5/16 x 1 1/2 Carb Stud Kit | (1) |
| 09112 | - Chrome Throttle Return Springs | (3) |
| 56220 | - License Plate Kit | (1) |
| 56461-H | - Header Bolts Kit | (1) |
| 56418-H | - S/B Header Bolts 1" Long Kit | (1) |
| 56477-H | - Exhaust Manifold w/ Flat Washers Kit | (1) |
| 56469-H | - Intake Manifold S/B Kit | (1) |

H= Hex Caps
Chrome Plated

Polished Chrome Allen Head Screw Kits

| Kit Part # | Description | Qty. of cards |
|------------|--|---------------|
| 56490-P | - S/B Chevy Engine Dress Up Kit | (1) |
| 56465-P | - Oil Pan Bolts S/B & LT-1 Kit | (1) |
| 56485-P | - Valve Covers B/B Kit | (1) |
| 56468-P | - Water Pump S/B Short Kit | (1) |
| 56464-P | - Timing Cover Kit | (1) |
| 56484-P | - Bell Housing Kit | (1) |
| 56220-B | - Bullet License Plate Kit | (1) |
| 56477-P | - Exhaust Manifold w/ Flat Washers Kit | (1) |
| 56469-P | - Intake Manifold S/B Kit | (1) |

P= Allen Screws
Polished Chrome
Plated

Polished Stainless Steel Hex Cap Kits

| Kit Part # | Description | Qty. of cards |
|------------|--|---------------|
| 56490-HSP | - S/B Chevy Engine Dress Up Kit | (1) |
| 56465-HSP | - S/B & LT-1 Oil Pan Bolts Kit | (1) |
| 56485-HSP | - B/B Steel Valve Covers Kit | (1) |
| 56468-HSP | - S/B Water Pump Short Kit | (1) |
| 56464-HSP | - Timing Cover Kit | (1) |
| 56484-HSP | - Bell Housing Kit | (1) |
| 56461-HSP | - S/B Header Bolt 3/4" Kit | (1) |
| 56477-HSP | - Exhaust Manifold Kit | (1) |
| 56469-HSP | - S/B Intake Manifold Kit | (1) |
| 4086 | - 1 3/8 Stainless Steel Carb Kit | (1) |
| 4084 | - 1 1/2 Stainless Steel Carb Kit | (1) |
| 09113 | - Stainless Steel Throttle Return Spring | (3) |

HSP= Hex Caps
Stainless Steel
Polished

Polished Stainless Steel Allen Head Screw Kits

| Kit Part # | Description | Qty. of cards |
|------------|---------------------------------|---------------|
| 56490-SSP | - S/B Chevy Engine Dress Up Kit | (1) |
| 56465-SSP | - S/B & LT-1 Oil Pan Bolts Kit | (1) |
| 56485-SSP | - B/B Valve Covers Kit | (1) |
| 56468-SSP | - S/B Water Pump Short Kit | (1) |
| 56464-SSP | - Timing Cover Kit | (1) |
| 56484-SSP | - Bell Housing Kit | (1) |
| 56461-SSP | - S/B Header Bolt Kit | (1) |
| 56477-SSP | - Exhaust Manifold Kit | (1) |
| 56469-SSP | - S/B Intake Manifold Kit | (1) |
| 56220-SSP | - License Plate Kit | (2) |

SSP= Allen Screws
Stainless Steel
Polished

Chrome Chevy Bow Tie Hex Cap Kits

| Kit Part # | Description | Qty. of cards |
|------------|--------------------------------------|---------------|
| 10-56490-H | - S/B Chevy Engine Dress Up Kit | (1) |
| 10-56495-H | - LT-1 Engine Dress Up Kit | (1) |
| 10-56465-H | - S/B Oil Pan Bolts Kit | (2) |
| 10-56463-H | - S/B Valve Cover Steel Kit | (2) |
| 10-56468-H | - S/B Short Water Pump Kit | (2) |
| 10-56467-H | - S/B Extended Water Pump Kit | (2) |
| 10-56464-H | - Timing Cover Kit | (2) |
| 10-56400-H | - Timing Cover LT-1 Kit | (2) |
| 10-56466-H | - S/B Valve Cover Aluminum Kit | (2) |
| 10-56478-H | - Coil Mt. to Blk. & Flat Washer Kit | (2) |
| 10-56461-H | - S/B Header Bolt Kit | (1) |
| 10-56418-H | - S/B Header Bolt 1" Long Kit | (1) |
| 10-56477-H | - Exhaust Manifold Kit | (2) |
| 10-56469-H | - S/B Intake Manifold Kit | (2) |

Polished Stainless Bow Tie Hex Caps Kits

| Kit Part # | Description | Qty. of cards |
|--------------|---------------------------------|---------------|
| 10-56490-HSP | - S/B Chevy Engine Dress Up Kit | (1) |
| 10-56491-HSP | - B/B Engine Dress Up Kit | (1) |
| 10-56465-HSP | - S/B Oil Pan Bolts Kit | (2) |
| 10-56463-HSP | - S/B Valve Cover Steel Kit | (2) |
| 10-56468-HSP | - S/B Short Water Pump Kit | (2) |
| 10-56467-HSP | - S/B Extended Water Pump Kit | (2) |
| 10-56464-HSP | - Timing Cover Kit | (2) |
| 10-56484-HSP | - Bell Housing Kit | (2) |
| 10-56466-HSP | - S/B Valve Cover Aluminum Kit | (2) |
| 10-56401-HSP | - License Plate Bolt Kit | (2) |
| 10-56461-HSP | - S/B Header Bolt Kit | (1) |
| 10-56418-HSP | - S/B Header Bolt 1" Long Kit | (1) |
| 10-56477-HSP | - Exhaust Manifold Kit | (2) |
| 10-56469-HSP | - S/B Intake Manifold Kit | (2) |

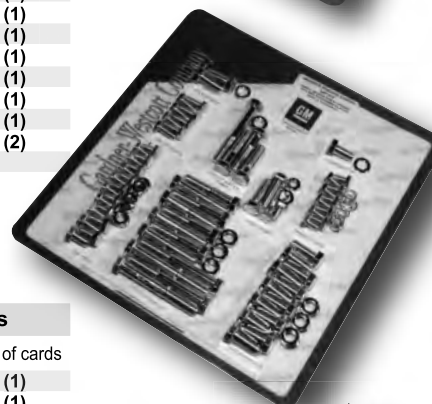
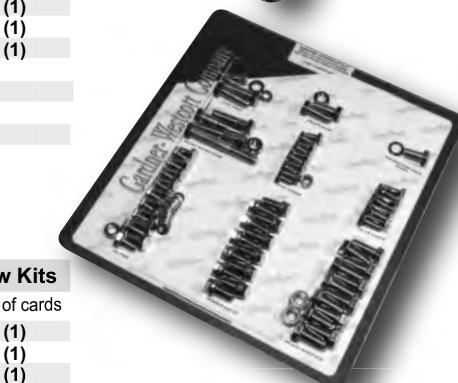



P.O.P Unit Descriptions



FULL FLOOR UNITS

J1POP-8 Chevy Bow Tie & Ford Oval Stamped Fastener Kits - contains (89) items in chrome and stainless steel (2 & 3) ea. carded kits of the following:

Chevy Bow Tie Hex Cap Chrome Plated and Stainless Steel Kits

| Engine Dress-Up Chrome Kits | | | Bow Tie Chrome Kits | | | Bow Tie Stainless Kits | | |
|-----------------------------|------------------------|---------------|---------------------|-----------------|---------------|------------------------|-----------------|---------------|
| Kit Part # | Description | Qty. of cards | Kit Part # | Description | Qty. of cards | Kit Part # | Description | Qty. of cards |
| 10-56490-H | S/B Engine Set | (2) | X-10-11206 | 1/4-20 x 1/2 | (3) | X-10-77206 | 1/4-20 X 1/2 | (3) |
| 10-56464-H | Front Cover | (3) | X-10-11210 | 1/4-20 x 3/4 | (3) | X-10-77210 | 1/4-20 x 3/4 | (3) |
| 10-56456-H | Short Fan Spacer Bolts | (3) | X-10-11214 | 1/4-20 x 1 | (3) | X-10-77214 | 1/4-20 x 1 | (3) |
| 10-56460-H | S/B Fuel Pump | (2) | X-10-11218 | 1/4-20 x 1 1/4 | (3) | X-10-77218 | 1/4-20 x 1 1/4 | (3) |
| 10-56461-H | Header Bolts | (2) | X-10-11220 | 1/4-20 x 1 1/2 | (3) | X-10-77220 | 1/4-20 x 1 1/2 | (3) |
| 10-56469-H | Intake Manifold | (2) | X-10-11224 | 1/4-20 x 2 | (3) | X-10-77224 | 1/4-20 x 2 | (3) |
| 10-56465-H | S/B & LT-1 Oil Pan | (3) | X-10-11274 | 5/16-18 x 3/4 | (3) | X-10-77274 | 5/16-18 x 3/4 | (3) |
| 10-56474-H | Trans Pan with Washers | (2) | X-10-11280 | 5/16-18 x 1 | (3) | X-10-77280 | 5/16-18 x 1 | (3) |
| 10-56463-H | Steel Valve Cover | (3) | X-10-11284 | 5/16-18 x 1 1/4 | (3) | X-10-77284 | 5/16-18 x 1 1/4 | (3) |
| 10-56471-H | Water Neck 45 W/F/W | (3) | X-10-11286 | 5/16-18 x 1 1/2 | (3) | X-10-77286 | 5/16-18 x 1 1/2 | (3) |
| 10-56468-H | Water Pump Short | (3) | X-10-11290 | 5/16-18 x 2 | (3) | X-10-77290 | 5/16-18 x 2 | (3) |
| 10-56401-H | License Plate Kit | (2) | X-10-11326 | 3/8-16 x 3/4 | (3) | X-10-77326 | 3/8-16 x 3/4 | (3) |
| | | | X-10-11330 | 3/8-16 x 1 | (3) | X-10-77330 | 3/8-16 x 1 | (3) |
| | | | X-10-11334 | 3/8-16 x 1 1/4 | (3) | X-10-77334 | 3/8-16 x 1 1/4 | (3) |
| | | | X-10-11336 | 3/8-16 x 1 1/2 | (3) | X-10-77336 | 3/8-16 x 1 1/2 | (3) |
| | | | X-10-11340 | 3/8-16 x 2 | (3) | X-10-77340 | 3/8-16 x 2 | (3) |



Ford Oval Hex Cap Chrome Plated and Stainless Steel Kits

| Engine Dress-Up Chrome Kits | | | Ford Oval Chrome Kits | | | Ford Oval Stainless Kits | | |
|-----------------------------|----------------------------|---------------|-----------------------|-----------------|---------------|--------------------------|-----------------|---------------|
| Kit Part # | Description | Qty. of cards | Kit Part # | Description | Qty. of cards | Kit Part # | Description | Qty. of cards |
| 11-56250-H | S/B Engine Set | (2) | X-11-11206 | 1/4-20 x 1/2 | (3) | X-11-77206 | 1/4-20 X 1/2 | (3) |
| 11-56240-H | 282, 302 Fuel Pump | (3) | X-11-11210 | 1/4-20 x 3/4 | (3) | X-11-77210 | 1/4-20 x 3/4 | (3) |
| 11-56223-H | 7/16 Header Bolts | (2) | X-11-11214 | 1/4-20 x 1 | (3) | X-11-77214 | 1/4-20 x 1 | (3) |
| 11-56231-H | 289, 302 Oil Pan | (3) | X-11-11218 | 1/4-20 x 1 1/4 | (3) | X-11-77218 | 1/4-20 x 1 1/4 | (3) |
| 11-56242-H | 289 Timing Cover | (3) | X-11-11220 | 1/4-20 x 1 1/2 | (3) | X-11-77220 | 1/4-20 x 1 1/2 | (3) |
| 11-56235-H | C-4 Transmission | (3) | X-11-11224 | 1/4-20 x 2 | (3) | X-11-77224 | 1/4-20 x 2 | (3) |
| 11-56224-H | 289 Steel Valve Cover | (3) | X-11-11274 | 5/16-18 x 3/4 | (3) | X-11-77274 | 5/16-18 x 3/4 | (3) |
| 11-56226-H | 428 Steel Valve Cover | (3) | X-11-11280 | 5/16-18 x 1 | (3) | X-11-77280 | 5/16-18 x 1 | (3) |
| 11-56230-H | Water Neck | (3) | X-11-11284 | 5/16-18 x 1 1/4 | (3) | X-11-77284 | 5/16-18 x 1 1/4 | (3) |
| 11-56260-H | 74 to 78 Mustang Front End | (3) | X-11-11286 | 5/16-18 x 1 1/2 | (3) | X-11-77286 | 5/16-18 x 1 1/2 | (3) |
| 11-56227-H | 289 Aluminum Valve Cover | (3) | X-11-11290 | 5/16-18 x 2 | (3) | X-11-77290 | 5/16-18 x 2 | (3) |
| 11-56233-H | 390, 428 Oil Pan | (3) | X-11-11326 | 3/8-16 x 3/4 | (3) | X-11-77326 | 3/8-16 x 3/4 | (3) |
| 11-56248-H | 302 Exhaust Manifold | (3) | X-11-11330 | 3/8-16 x 1 | (3) | X-11-77330 | 3/8-16 x 1 | (3) |
| | | | X-11-11334 | 3/8-16 x 1 1/4 | (3) | X-11-77334 | 3/8-16 x 1 1/4 | (3) |
| | | | X-11-11336 | 3/8-16 x 1 1/2 | (3) | X-11-77336 | 3/8-16 x 1 1/2 | (3) |
| | | | X-11-11340 | 3/8-16 x 2 | (3) | X-11-77340 | 3/8-16 x 2 | (3) |



When limited space is a commodity and you want your products to be organized, easy to maintain and reordering to be a snap. Than our Point of Purchase Product Display Floor Units will meet your requirements and more.



P.O.P. Unit Descriptions

FULL FLOOR UNITS



J1POP-9 Chevy, Ford and Chrysler Stamped Fastener Kits with various Chrome Plated Brass Fittings - this unit contains (77) items (1-3) ea. carded kits of the following:



Chevy Bow Tie Chrome Kits

| Kit Part # | Description | Qty. of cards |
|------------|-------------------------------------|---------------|
| 10-56490-H | - S/B w/Headers Engine Dress Up Kit | (2) |
| 10-56491-H | - B/B w/headers Engine Dress Up Kit | (2) |
| 10-56488-H | - B/B Header Bolt Kit | (3) |
| 10-56487-H | - B/B Oil Pan Kit | (3) |
| 10-56486-H | - B/B Aluminum Valve Cover Kit | (3) |
| 10-56467-H | - S/B Extended Water Pump Kit | (3) |
| 10-56479-H | - B/B Intake Manifold Kit | (3) |
| 10-56477-H | - Exhaust Manifold Kit | (3) |
| 10-56489-H | - B/B Long Valve Cover Kit | (3) □ |
| 10-56464-H | - S/B Timing Cover Kit | (3) |
| 10-56456-H | - Fan Spacer Bolt Short Kit | (3) |
| 10-56460-H | - S/B Fuel Pump Kit | (3) |
| 10-56461-H | - S/B Header Bolt Kit | (3) |
| 10-56469-H | - S/B Intake Manifold Kit | (3) |
| 10-56465-H | - S/B Oil Pan Kit | (3) |
| 10-56466-H | - S/B Aluminum Valve Cover Kit | (3) |
| 10-56471-H | - S/B 45° Water Neck Kit | (3) |
| 10-56468-H | - S/B Short Water Pump Kit | (3) |

Ford Oval Chrome Kits

| Kit Part # | Description | Qty. of cards |
|------------|--|---------------|
| 11-56250-H | - S/B w/Headers Engine Dress Up Kit | (2) |
| 11-56240-H | - 282, 302 Fuel Pump Kit | (3) |
| 11-56223-H | - 7/16 Header Bolt Kit | (3) |
| 11-56231-H | - 289, 302 Oil Pan Kit | (3) |
| 11-56242-H | - 289 Timing Cover Kit | (3) |
| 11-56235-H | - C-4 Transmission Pan Cover Kit | (3) |
| 11-56224-H | - 289 Steel Valve Cover Kit | (3) |
| 11-56226-H | - 428 Steel Valve Cover Kit | (3) |
| 11-56230-H | - Water Neck Kit | (3) □ |
| 11-56227-H | - 289 Aluminum Valve Cover Kit | (3) |
| 11-56233-H | - 390, 428 Oil Pan Kit | (3) |
| 11-56248-H | - 289, 302 Exhaust Manifold Kit | (3) |
| 11-56260-H | - 74-78 Mustang Front End Kit | (1) |
| 09012 | - Chrome Plated Throttle Return Spring | (2) |
| 09015 | - Gold Plated Throttle Return Spring | (2) |



Mopar Chrome Kits

| Kit Part # | Description | Qty. of cards |
|------------|-------------------------------------|---------------|
| 23-56330-H | - S/B w/Headers Engine Dress Up Kit | (2) |
| 23-56332-H | - B/B w/Headers Engine Dress Up Kit | (2) |
| 23-56301-H | - S/B Oil Pan Kit | (3) |
| 23-56303-H | - S/B Header Bolt Kit | (3) |
| 23-56304-H | - S/B Valve Cover Kit | (3) |
| 23-56305-H | - S/B Water Pump Kit | (3) |
| 23-56306-H | - S/B Fuel Pump Kit | (3) |
| 23-56302-H | - S/B Intake Manifold Kit | (3) |
| 23-56307-H | - B/B Oil Pan Kit | (3) □ |
| 23-56308-H | - B/B Intake Manifold Kit | (3) |
| 23-56309-H | - B/B Header Bolt Kit | (3) |
| 23-56310-H | - B/B Valve Cover Kit | (3) |
| 23-56311-H | - B/B Water Pump Kit | (3) |
| 23-56312-H | - B/B Fuel Pump Kit | (3) |

Chrome Plated Brass Fittings

| Kit Part # | Description | Qty. of cards |
|------------|---|---------------|
| J9015 | - 1/4 Socket Pipe Plug | (2) |
| J9016 | - 3/8 Socket Pipe Plug | (2) |
| J9017 | - 1/2 Socket Pipe Plug | (2) |
| J9019 | - 3/8 x 1/8 Pipe Bushing | (2) |
| J9020 | - 3/8 x 1/4 Pipe Bushing | (2) |
| J9021 | - 1/8 Street Elbow | (2) |
| J9025 | - Adapter 1/8 x 1/8 | (2) |
| J9026 | - Straight Hose Barb Male Pipe 3/16 x 1/8 | (2) |
| J9030 | - Straight Hose Barb Male Pipe 3/8 x 1/4 | (2) □ |
| J9031 | - 90° Hose Barb Male Pipe 5/16 x 1/8 | (2) |
| J9032 | - 90° Hose Barb Male Pipe 3/8 x 1/8 | (2) |
| J9033 | - 90° Hose Barb Male Pipe 3/8 x 1/4 | (2) |
| J9034 | - 3/16 Brake Line Tee with Mount | (2) |
| J9035 | - Inverted Flare Union Tee 3/16 | (2) |

Chrome Plated Brass Fittings

| Kit Part # | Description | Qty. of cards |
|------------|--|---------------|
| J9001 | - 90° Heater Hose Barb 5/8 x 1/2 | (2) |
| J9002 | - 90° Heater Hose Barb 5/8 x 3/8 | (2) |
| J9003 | - Straight Heater Hose Barb 3/8 x 1/2 | (2) |
| J9004 | - Straight Heater Hose Barb 5/8 x 3/8 | (2) |
| J9005 | - Straight Heater Hose Barb 3/4 x 1/2 | (2) |
| J9006 | - 1/2 Hex Head Pipe Plug | (2) |
| J9007 | - 3/8 Hex Head Pipe Plug | (2) |
| J9010 | - Inverted Flare 45° Male Elbow 3/16 x 1/8 | (2) |
| J9014 | - 1/8 Socket Pipe Plug | (2) |

Chrome Plated Brass Fittings

| Kit Part # | Description | Qty. of cards |
|------------|---------------------------------------|---------------|
| J9038 | - 1/4 Drain Cocks | (2) |
| J9040 | - Inverted Flare Male Pipe 3/16 x 1/8 | (2) |
| J9041 | - Inverted Flare Female Branch Tee | (2) |
| J9044 | - Male Pipe Rigid Hose Barb 1/4 x 1/8 | (2) |
| J9045 | - Male Pipe Rigid Hose Barb 3/8 x 1/4 | (2) |
| J9047 | - Brake Bleeder Screws 3/8-24 x 1 1/2 | (2) |
| J9048 | - Brake Bleeder Screws 5/16-24 x 1 | (2) |
| J9049 | - Brake Bleeder Screws 1/4-28 x 1 | (2) |



P.O.P Unit Descriptions



COUNTER TOP UNITS

J1POP-10 Metric Hex Cap Screws, Hex Nuts and Flat Washers in Chrome - contains (48) items and (3) ea. carded kits of the following:

Chrome Metric Hex Cap Screw Kits (Side 1)

| Kit Part # | Description | Qty. of cards | Qty. per card |
|------------|------------------|---------------|---------------|
| X-11725 | - 5mm x 0.8 x 16 | (3) | (4) |
| X-11726 | - 5mm x 0.8 x 20 | (3) | (4) |
| X-11727 | - 5mm x 0.8 x 25 | (3) | (4) |
| X-11728 | - 5mm x 0.8 x 30 | (3) | (4) |
| X-11729 | - 5mm x 0.8 x 35 | (3) | (4) |
| X-11730 | - 5mm x 0.8 x 40 | (3) | (4) |
| X-11731 | - 5mm x 0.8 x 45 | (3) | (4) |
| X-11732 | - 5mm x 0.8 x 50 | (3) | (4) |
| X-11738 | - 6mm x 1.0 x 16 | (3) | (4) |
| X-11739 | - 6mm x 1.0 x 20 | (3) | (4) |
| X-11740 | - 6mm x 1.0 x 25 | (3) | (4) |
| X-11741 | - 6mm x 1.0 x 30 | (3) | (4) |

Chrome Metric Hex Cap Screw Kits (Side 3)

| Kit Part # | Description | Qty. of cards | Qty. per card |
|------------|--------------------|---------------|---------------|
| X-11794 | - 10mm x 1.5 x 20 | (3) | (3) |
| X-11795 | - 10mm x 1.5 x 25 | (3) | (3) |
| X-11796 | - 10mm x 1.5 x 30 | (3) | (3) |
| X-11797 | - 10mm x 1.5 x 35 | (3) | (3) |
| X-11798 | - 10mm x 1.5 x 40 | (3) | (3) |
| X-11799 | - 10mm x 1.5 x 45 | (3) | (3) |
| X-11800 | - 10mm x 1.5 x 50 | (3) | (3) |
| X-11835 | - 12mm x 1.75 x 20 | (3) | (3) |
| X-11836 | - 12mm x 1.75 x 25 | (3) | (3) |
| X-11837 | - 12mm x 1.75 x 30 | (3) | (3) |
| X-11838 | - 12mm x 1.75 x 35 | (3) | (3) |
| X-11839 | - 12mm x 1.75 x 40 | (3) | (3) |

Chrome Metric Hex Cap Screw Kits (Side 2)

| Kit Part # | Description | Qty. of cards | Qty. per card |
|------------|-------------------|---------------|---------------|
| X-11742 | - 6mm x 1.0 x 35 | (3) | (4) |
| X-11743 | - 6mm x 1.0 x 40 | (3) | (4) |
| X-11744 | - 6mm x 1.0 x 45 | (3) | (4) |
| X-11745 | - 6mm x 1.0 x 50 | (3) | (4) |
| X-11773 | - 8mm x 1.25 x 20 | (3) | (4) |
| X-11774 | - 8mm x 1.25 x 25 | (3) | (4) |
| X-11775 | - 8mm x 1.25 x 30 | (3) | (4) |
| X-11776 | - 8mm x 1.25 x 35 | (3) | (4) |
| X-11777 | - 8mm x 1.25 x 40 | (3) | (4) |
| X-11778 | - 8mm x 1.25 x 45 | (3) | (4) |
| X-11779 | - 8mm x 1.25 x 50 | (3) | (4) |
| X-11781 | - 8mm x 1.25 x 60 | (3) | (4) |

Chrome Metric Hex Cap Screw Kits (Side 4)

| Kit Part # | Description | Qty. of cards | Qty. per card |
|------------|--------------------|---------------|---------------|
| X-11840 | - 12mm x 1.75 x 45 | (3) | (3) |
| X-11841 | - 12mm x 1.75 x 50 | (3) | (3) |

Chrome Metric Hex Nut Kits

| Kit Part # | Description | Qty. of cards | Qty. per card |
|------------|---------------|---------------|---------------|
| X-15952 | - 5mm x .80 | (3) | (6) |
| X-15954 | - 6mm x 1.0 | (3) | (6) |
| X-15958 | - 8mm x 1.25 | (3) | (6) |
| X-15962 | - 10mm x 1.50 | (3) | (6) |
| X-15966 | - 12mm x 1.75 | (3) | (4) |

Chrome Metric Flat Washer Kits

| Kit Part # | Description | Qty. of cards | Qty. per card |
|------------|-------------|---------------|---------------|
| X-23986 | - 5mm | (3) | (10) |
| X-23987 | - 6mm | (3) | (10) |
| X-23989 | - 8mm | (3) | (10) |
| X-23990 | - 10mm | (3) | (8) |
| X-23991 | - 12mm | (3) | (8) |

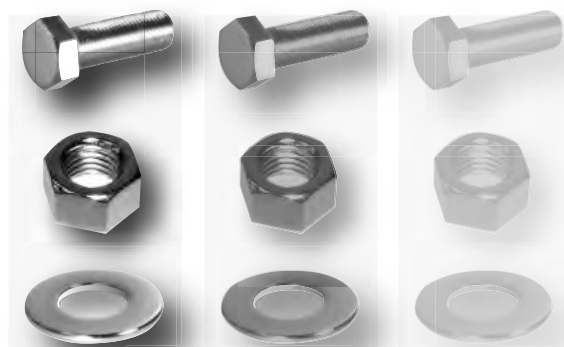



P.O.P. Unit Descriptions

FULL FLOOR UNITS



J1POP-11 Ford Oval Stamped and Non-Stamped Hex Cap Engine Dress Up Kits - contains (50) items in chrome and polished stainless steel (2 & 3) ea. carded kits of the following:



Ford Oval Chrome Kits

| Kit Part # | Description | Qty. of cards |
|------------|------------------------------|---------------|
| 11-56250-H | S/B Engine Set Hex Caps | (2) |
| 11-56240-H | 282, 302 Fuel Pump | (3) |
| 11-56223-H | 7/16 Header Bolts | (3) |
| 11-56231-H | 289, 302 Oil Pan | (3) |
| 11-56242-H | 289 Timing Cover | (3) |
| 11-56235-H | C-4 Transmission | (3) |
| 11-56224-H | 289 Steel Valve Cover | (3) |
| 11-56226-H | 428 Steel Valve Cover | (3) |
| 11-56230-H | Water Neck | (3) |
| 11-56260-H | 74 thru 78 Mustang Front End | (3) |
| 11-56227-H | 289 Aluminum Valve Cover | (3) |
| 11-56233-H | 390, 428 Oil Pan | (3) |
| 11-56248-H | 302 Exhaust Manifold | (3) |

Ford Oval Stainless Steel Kits

| Kit Part # | Description | Qty. of cards |
|--------------|--------------------------|---------------|
| 11-56250-HSP | S/B Engine Set Hex Caps | (2) |
| 11-56240-HSP | 282, 302 Fuel Pump | (3) |
| 11-56223-HSP | 7/16 Header Bolts | (3) |
| 11-56231-HSP | 289, 302 Oil Pan | (3) |
| 11-56242-HSP | 289 Timing Cover | (3) |
| 11-56235-HSP | C-4 Transmission | (3) |
| 11-56224-HSP | 289 Steel Valve Cover | (3) |
| 11-56226-HSP | 428 Steel Valve Cover | (3) |
| 11-56230-HSP | Water Neck | (3) |
| 11-56227-HSP | 289 Aluminum Valve Cover | (3) |
| 11-56233-HSP | 390, 428 Oil Pan | (3) |
| 11-56248-HSP | 302 Exhaust Manifold | (3) |

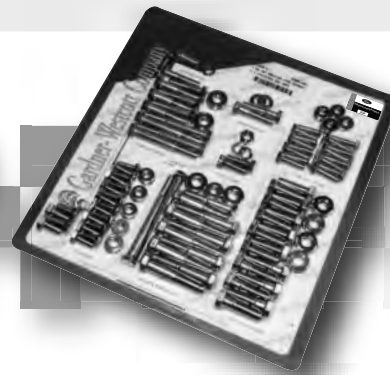

Engine Dress Up Kit
Part # 56250-HSP

Ford Standard Chrome Kits

| Kit Part # | Description | Qty. of cards |
|------------|------------------------------|---------------|
| 56250-H | S/B Engine Set Hex Caps | (2) |
| 56240-H | 282, 302 Fuel Pump | (3) |
| 56223-H | 7/16 Header Bolts | (3) |
| 56231-H | 289, 302 Oil Pan | (3) |
| 56242-H | 289 Timing Cover | (3) |
| 56235-H | C-4 Transmission | (3) |
| 56224-H | 289 Steel Valve Cover | (3) |
| 56226-H | 428 Steel Valve Cover | (3) |
| 56230-H | Water Neck | (3) |
| 56260-H | 74 thru 78 Mustang Front End | (3) |
| 56227-H | 289 Aluminum Valve Cover | (3) |
| 56233-H | 390, 428 Oil Pan | (3) |
| 56248-H | 302 Exhaust Manifold | (3) |

Ford Standard Stainless Steel Kits

| Kit Part # | Description | Qty. of cards |
|------------|--------------------------|---------------|
| 56250-HSP | S/B Engine Set Hex Caps | (2) |
| 56240-HSP | 282, 302 Fuel Pump | (3) |
| 56223-HSP | 7/16 Header Bolts | (3) |
| 56231-HSP | 289, 302 Oil Pan | (3) |
| 56242-HSP | 289 Timing Cover | (3) |
| 56235-HSP | C-4 Transmission | (3) |
| 56224-HSP | 289 Steel Valve Cover | (3) |
| 56226-HSP | 428 Steel Valve Cover | (3) |
| 56230-HSP | Water Neck | (3) |
| 56227-HSP | 289 Aluminum Valve Cover | (3) |
| 56233-HSP | 390, 428 Oil Pan | (3) |
| 56248-HSP | 302 Exhaust Manifold | (3) |



P.O.P Unit Descriptions



COUNTER TOP UNITS

J1POP-10 Metric Hex Cap Screws, Hex Nuts and Flat Washers in Stainless Steel - contains (48) items and (3) ea. carded kits of the following:

Stainless Steel Metric Hex Cap Screw Kits (Side 1)

| Kit Part # | Description | Qty. of cards | Qty. per card |
|------------|------------------|---------------|---------------|
| X-77725 | - 5mm x 0.8 x 16 | (3) | (4) |
| X-77726 | - 5mm x 0.8 x 20 | (3) | (4) |
| X-77727 | - 5mm x 0.8 x 25 | (3) | (4) |
| X-77728 | - 5mm x 0.8 x 30 | (3) | (4) |
| X-77729 | - 5mm x 0.8 x 35 | (3) | (4) |
| X-77730 | - 5mm x 0.8 x 40 | (3) | (4) |
| X-77731 | - 5mm x 0.8 x 45 | (3) | (4) |
| X-77732 | - 5mm x 0.8 x 50 | (3) | (4) |
| X-77738 | - 6mm x 1.0 x 16 | (3) | (4) |
| X-77739 | - 6mm x 1.0 x 20 | (3) | (4) |
| X-77740 | - 6mm x 1.0 x 25 | (3) | (4) |
| X-77741 | - 6mm x 1.0 x 30 | (3) | (4) |

Stainless Steel Metric Hex Cap Screw Kits (Side 2)

| Kit Part # | Description | Qty. of cards | Qty. per card |
|------------|-------------------|---------------|---------------|
| X-77742 | - 6mm x 1.0 x 35 | (3) | (4) |
| X-77743 | - 6mm x 1.0 x 40 | (3) | (4) |
| X-77744 | - 6mm x 1.0 x 45 | (3) | (4) |
| X-77745 | - 6mm x 1.0 x 50 | (3) | (4) |
| X-77773 | - 8mm x 1.25 x 20 | (3) | (4) |
| X-77774 | - 8mm x 1.25 x 25 | (3) | (4) |
| X-77775 | - 8mm x 1.25 x 30 | (3) | (4) |
| X-77776 | - 8mm x 1.25 x 35 | (3) | (4) |
| X-77777 | - 8mm x 1.25 x 40 | (3) | (4) |
| X-77778 | - 8mm x 1.25 x 45 | (3) | (4) |
| X-77779 | - 8mm x 1.25 x 50 | (3) | (4) |
| X-77781 | - 8mm x 1.25 x 60 | (3) | (4) |

Stainless Steel Metric Hex Cap Screw Kits (Side 3)

| Kit Part # | Description | Qty. of cards | Qty. per card |
|------------|--------------------|---------------|---------------|
| X-77794 | - 10mm x 1.5 x 20 | (3) | (3) |
| X-77795 | - 10mm x 1.5 x 25 | (3) | (3) |
| X-77796 | - 10mm x 1.5 x 30 | (3) | (3) |
| X-77797 | - 10mm x 1.5 x 35 | (3) | (3) |
| X-77798 | - 10mm x 1.5 x 40 | (3) | (3) |
| X-77799 | - 10mm x 1.5 x 45 | (3) | (3) |
| X-77800 | - 10mm x 1.5 x 50 | (3) | (3) |
| X-77835 | - 12mm x 1.75 x 20 | (3) | (3) |
| X-77836 | - 12mm x 1.75 x 25 | (3) | (3) |
| X-77837 | - 12mm x 1.75 x 30 | (3) | (3) |
| X-77838 | - 12mm x 1.75 x 35 | (3) | (3) |
| X-77839 | - 12mm x 1.75 x 40 | (3) | (3) |

Stainless Steel Metric Hex Cap Screw Kits (Side 4)

| Kit Part # | Description | Qty. of cards | Qty. per card |
|------------|--------------------|---------------|---------------|
| X-77840 | - 12mm x 1.75 x 45 | (3) | (3) |
| X-77841 | - 12mm x 1.75 x 50 | (3) | (3) |

Stainless Steel Metric Hex Nut Kits

| Kit Part # | Description | Qty. of cards | Qty. per card |
|------------|---------------|---------------|---------------|
| X-70952 | - 5mm x .80 | (3) | (6) |
| X-70954 | - 6mm x 1.0 | (3) | (6) |
| X-70958 | - 8mm x 1.25 | (3) | (6) |
| X-70962 | - 10mm x 1.50 | (3) | (6) |
| X-70966 | - 12mm x 1.75 | (3) | (4) |

Stainless Steel Metric Flat Washer Kits

| Kit Part # | Description | Qty. of cards | Qty. per card |
|------------|-------------|---------------|---------------|
| X-75986 | - 5mm | (3) | (10) |
| X-75987 | - 6mm | (3) | (10) |
| X-75989 | - 8mm | (3) | (10) |
| X-75990 | - 10mm | (3) | (8) |
| X-75991 | - 12mm | (3) | (8) |

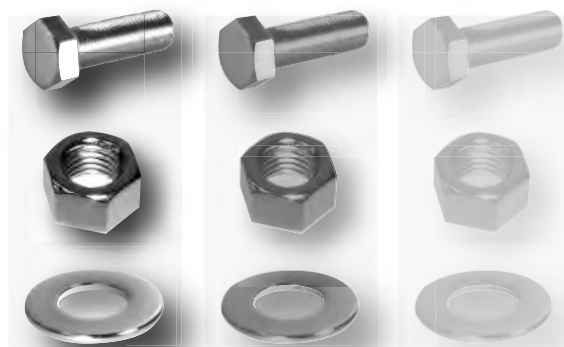



P.O.P. Unit Descriptions

COUNTER TOP UNITS



J1POP-14 Ford and Ford Oval Stamped Hex Cap Engine Dress Up Kits
Contains (24) items in chrome (2 & 3) ea. carded kits of the following:

Ford Chrome Kits

| Kit Part # | Description | Qty. of cards |
|------------|------------------------------|---------------|
| 56250-H | S/B Engine Dress Up Set | (2) |
| 56221-H | 289, 302 Intake Manifold Kit | (3) |
| 56240-H | 282, 302 Fuel Pump Kit | (3) |
| 56223-H | 7/16 Header Bolts Kit | (3) |
| 56231-H | 289, 302 Oil Pan Kit | (3) |
| 56242-H | 289 Timing Cover Kit | (3) |
| 56224-H | 289 Steel Valve Cover Kit | (3) |
| 56230-H | Water Neck Kit | (3) |
| 56220-H | License Plate Kit | (3) |
| 56401-H | License Plate Bolt Kit | (3) |
| 11-56250-H | S/B Engine Set Hex Caps | (2) |

Ford Oval Chrome Kits

| Kit Part # | Description | Qty. of cards |
|------------|-------------------------------|---------------|
| 11-56221-H | 289, 302 Intake Manifold | (3) |
| 11-56240-H | 282, 302 Fuel Pump | (3) |
| 11-56223-H | 7/16 Header Bolts | (3) |
| 11-56231-H | 289, 302 Oil Pan | (3) |
| 11-56242-H | 289 Timing Cover | (3) |
| 11-56224-H | 289 Steel Valve Cover | (3) |
| 11-56230-H | Water Neck | (3) |
| 09012-blk | Black Throttle Return Spring | (3) |
| 09012-re | Red Throttle Return Spring | (3) |
| 09012-wht | White Throttle Return Spring | (3) |
| 09012-blu | Blue Throttle Return Spring | (3) |
| 09012 | Chrome Throttle Return Spring | (3) |



FULL FLOOR UNITS

J1POP-15 Ford Oval Stamped Hex Cap Engine Dress Up Kits
Contains (63) items in chrome (2 & 3) ea. carded kits of the following:

Ford Oval Chrome Kits

| Kit Part # | Description | Qty. of cards | Kit Part # | Description | Qty. of cards |
|------------|--|---------------|---------------|-------------------------|---------------|
| 11-56256-H | 400 w/St'rd Exhaust Eng. Dress Up Kit | (2) | X-11-11206 | 1/4-20 x 1/2 | (3) |
| 11-56255-H | 351 Cleveland Engine Dress Up Kit | (2) | X-11-11208 | 1/4-20 x 5/8 | (3) |
| 11-56254-H | 429, 460 w/Headers Eng. Dress Up Kit | (2) | X-11-11210 | 1/4-20 x 3/4 | (3) |
| 11-56253-H | 390, 428 w/Headers Eng. Dress Up Kit | (2) | X-11-11212 | 1/4-20 x 7/8 | (3) |
| 11-56251-H | 289, 302 w/St'rd Exhaust Eng. Dress Up Kit | (2) | X-11-11214 | 1/4-20 x 1 | (3) |
| 11-56250-H | 289, 302 w/Headers Eng. Dress Up Kit | (2) | X-11-11218 | 1/4-20 x 1 1/4 | (3) |
| 11-56248-H | 302 Exhaust Manifold Kit | (3) | X-11-11222 | 1/4-20 x 1 3/4 | (3) |
| 11-56247-H | 390, 428 Intake Manifold Kit | (3) | X-11-11220 | 1/4-20 x 1 1/2 | (3) |
| 11-56246-H | 429 Intake Manifold Kit | (3) | X-11-11224 | 1/4-20 x 2 | (3) |
| 11-56242-H | 289 Timing Cover Kit | (3) | X-11-11270 | 5/16-18 x 1/2 | (3) |
| 11-56240-H | 289, 302 Fuel Pump Kit | (3) | X-11-11272 | 5/16-18 x 5/8 | (3) |
| 11-56238-H | 390, 429 Fuel Pump Kit | (3) | X-11-11274 | 5/16-18 x 3/4 | (3) |
| 11-56237-H | 429, 460 Oil Pan Kit | (3) | X-11-11278 | 5/16-18 x 7/8 | (3) |
| 11-56235-H | C-4 Transmission Kit | (3) | X-11-11280 | 5/16-18 x 1 | (3) |
| 11-56234-H | C-6 Trans Pan Kit | (3) | X-11-11284 | 5/16-18 x 1 1/4 | (3) |
| 11-56233-H | 390, 428 Oil Pan Kit | (3) | X-11-11286 | 5/16-18 x 1 1/2 | (3) |
| 11-56231-H | 289, 302 Oil Pan Kit | (3) | X-11-11288 | 5/16-18 x 1 3/4 | (3) |
| 11-56230-H | Water Neck Kit | (3) | X-11-11290 | 5/16-18 x 2 | (3) |
| 11-56229-H | 429, 460 Valve Cover Kit | (3) | X-11-11326 | 3/8-16 x 3/4 | (3) |
| 11-56227-H | 289 Aluminum Valve Cover Kit | (3) | X-11-11330 | 3/8-16 x 1 | (3) |
| 11-56226-H | 428 Steel Valve Cover Kit | (3) | X-11-11334 | 3/8-16 x 1 1/4 | (3) |
| 11-56224-H | 289 Steel Valve Cover Kit | (3) | X-11-11336 | 3/8-16 x 1 1/2 | (3) |
| 11-56223-H | 7/16 Header Bolts Kit | (3) | X-11-11338 | 3/8-16 x 1 3/4 | (3) |
| 11-56222-H | 351 Cleveland Intake Manifold Kit | (3) | X-11-11340 | 3/8-16 x 2 | (3) |
| 11-56221-H | 289 Intake Manifold Kit | (3) | X-11-55669-P3 | 14 x 3/4 3/8 Hex | (3) |
| 11-56260-H | 74-78 Mustang Front End Kit | (2) | X-11-56669-P7 | 14 x 3/4 7/16 Hex | (3) |
| 11-56261-H | Rack Bolts 5/8 x 4" Grade 8 | (3) | X-11-22276 | 5/16 X 13/16 Body Bolts | (3) |
| 11-56220-H | License Plate Stamped Ford Oval Kit | (3) | X-11-22284 | 5/16 X 1 1/4 Body Bolts | (3) |
| 11-56401-H | License Plate for Plastic Ford Oval Kit | (3) | X-11-25212 | 1/4-20 x 7/8 | (3) |
| J1784 | License Plate Truss Slot Kit | (3) | X-11-25280 | 5/16-18 x 1 | (3) |
| X-11-25330 | 3/8-16 x 1 Sems | (3) | X-11-25336 | 3/8-16 x 1 1/2 Sems | (3) |





P.O.P Unit Descriptions



87

FULL FLOOR UNITS

J1POP-16 Pontiac Engine Dress Up Kits with Pontiac and GT Stamped Hex Caps - contains (68) items in chrome (2 & 3) ea. carded kits of the following:

Engine Dress-Up Chrome Kits

| Kit Part # | Description | Qty. of cards | Kit Part # | Description | Qty. of cards |
|-------------|---------------------------------|---------------|------------|----------------------------------|---------------|
| 56500-H | - S/B Engine Dress Up Kit | (2) | 12-56500-H | - S/B Engine Dress Up Kit | (2) |
| 56522-H | - 326 S/B Intake Manifold Kit | (3) | 12-56522-H | - 326 S/B Intake Manifold Kit | (3) |
| 56521-H | - 350 B/B Intake Manifold Kit | (3) | 12-56521-H | - 350 B/B Intake Manifold Kit | (3) |
| 56533-H | - Water Pump Kit | (3) | 12-56533-H | - Water Pump Kit | (3) |
| 56515-H | - 350 B/B Timing Cover Kit | (3) | 12-56515-H | - 350 B/B Timing Cover Kit | (3) |
| 56531-H | - 350, 389 Oil Pan Kit | (3) | 12-56531-H | - 350, 389 Oil Pan Kit | (3) |
| 56532-H | - 326, 453 Oil Pan Kit | (3) | 12-56532-H | - 326, 453 Oil Pan Kit | (3) |
| 56529-H | - 350 Aluminum Valve Cover Kit | (3) | 12-56529-H | - 350 Aluminum Valve Cover Kit | (3) |
| 56528-H | - 326 S/B Valve Cover Kit | (3) | 12-56528-H | - 326 S/B Valve Cover Kit | (3) |
| 56516-H | - 326 S/B Timing Cover Kit | (3) | 12-56516-H | - 326 S/B Timing Cover Kit | (3) |
| 56519-H | - Fuel Pump Kit | (3) | 12-56519-H | - Fuel Pump Kit | (3) |
| 56505-H | - B/B Engine Dress Up Kit | (2) | 12-56505-H | - B/B Engine Dress Up Kit | (2) |
| 56220-H | - License Plate Kit | (3) | 12-56220-H | - Pontiac Logo License Plate Kit | (3) |
| 56220-B | - Bullet License Plate Kit | (3) | 15-56500-H | - S/B Engine Dress Up Kit | (2) |
| 09012 | - Chrome Throttle Return Spring | (3) | 15-56522-H | - 326 S/B Intake Manifold Kit | (3) |
| 09015 | - Gold Throttle Return Spring | (3) | 15-56521-H | - 350 B/B Intake Manifold Kit | (3) |
| 09012-black | - Black Throttle Return Spring | (3) | 15-56533-H | - Water Pump Kit | (3) |
| 09012-red | - Red Throttle Return Spring | (3) | 15-56515-H | - 350 B/B Timing Cover Kit | (3) |
| 09012-white | - White Throttle Return Spring | (3) | 15-56531-H | - 350, 389 Oil Pan Kit | (3) |
| 09012-blue | - Blue Throttle Return Spring | (3) | 15-56532-H | - 326, 453 Oil Pan Kit | (3) |
| X-29591 | - 3/32 x 1 1/4 Cotter Pin | (3) | 15-56529-H | - 350 Aluminum Valve Cover Kit | (3) |
| X-29587 | - 3/32 x 1 3/4 Cotter Pin | (3) | 15-56528-H | - 326 S/B Valve Cover Kit | (3) |
| X-29593 | - 1/8 x 1 1/4 Cotter Pin | (3) | 15-56516-H | - 326 S/B Timing Cover Kit | (3) |
| X-29585 | - 1/8 x 1 1/2 Cotter Pin | (3) | 15-56519-H | - Fuel Pump Kit | (3) |
| X-29588 | - 5/32 x 1 1/2 Cotter Pin | (3) | 15-56505-H | - B/B Engine Dress Up Kit | (2) |
| X-25212 | - 1/4-20 X 7/8 Sems | (3) | 15-56220-H | - GT Logo License Plate Kit | (3) |
| X-25280 | - 5/16-18 x 1 Sems | (3) | X-43567 | - 3/16 Hole Plug | (3) |
| X-25326 | - 3/8-16 x 3/4 Sems | (3) | X-43569 | - 1/4 Hole Plug | (3) |
| X-25330 | - 3/8-16 x 1 Sems | (3) | X-43570 | - 5/16 Hole Plug | (3) |
| X-25336 | - 3/8-16 x 1 1/2 Sems | (3) | X-43571 | - 3/8 Hole Plug | (3) |
| 4083 | - 5/16 x 1 3/8 Carb Studs | (3) | X-43572 | - 7/16 Hole Plug | (3) |
| 4084 | - 5/16 x 1 1/2 Carb Studs | (3) | X-43573 | - 1/2 Hole Plug | (3) |
| 4085 | - 5/16 x 2 Carb Studs | (3) □ | X-43575 | - 5/8 Hole Plug | (3) |
| | | | X-43576 | - 3/4 Hole Plug | (3) |





P.O.P. Unit Descriptions

FULL FLOOR UNITS

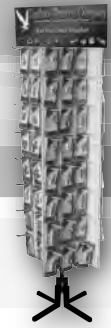

J2POP-1 is a combination of J1POP-1 and J1POP-2 Units

Contains (96) items all in chrome (2) ea. carded kits of the following fasteners:

Chrome Hex Nuts and Hex Cap Screws

| Kit Part # | Description | Qty. per card | Kit Part # | Description | Qty. per card | Kit Part # | Description | Qty. per card |
|------------|------------------|---------------|------------|--------------------------|---------------|------------|--------------------------|---------------|
| J0765 | 10/24 Hex Nuts | (12) | J0012 | 1/4-20 x 1/2 Hex Caps | (4) | J0108 | 3/8-16 x 1 1/2 Hex Caps | (4) |
| J0766 | 10/32 Hex Nuts | (12) | J0016 | 1/4-20 x 3/4 Hex Caps | (4) | J0110 | 3/8-16 x 1 3/4 Hex Caps | (4) |
| J0768 | 1/4-20 Hex Nuts | (15) | J0020 | 1/4-20 x 1 Hex Caps | (4) | J0112 | 3/8-16 x 2 Hex Caps | (4) |
| J0769 | 1/4-28 Hex Nuts | (15) | J0050 | 5/16-18 x 5/8 Hex Caps | (4) | J0114 | 3/8-16 x 2 1/4 Hex Caps | (4) |
| J0770 | 5/16-18 Hex Nuts | (13) | J0052 | 5/16-18 x 3/4 Hex Caps | (4) | J0116 | 3/8-16 x 2 1/2 Hex Caps | (4) |
| J0771 | 5/24-24 Hex Nuts | (13) | J0053 | 5/16-24 x 3/4 Hex Caps | (4) | J0118 | 3/8-16 x 2 3/4 Hex Caps | (3) |
| J0772 | 3/8-16 Hex Nuts | (11) | J0056 | 5/16-18 x 1 Hex Caps | (4) | J0120 | 3/8-16 x 3 Hex Caps | (3) |
| J0773 | 3/8-24 Hex Nuts | (11) | J0059 | 5/16-18 x 1 1/4 Hex Caps | (4) | J0148 | 7/16-14 x 1 Hex Caps | (3) |
| J0774 | 7/16-14 Hex Nuts | (7) | J0065 | 5/16-18 x 2 Hex Caps | (4) | J0150 | 7/16-14 x 1 1/4 Hex Caps | (3) |
| J0775 | 7/16-20 Hex Nuts | (7) | J0068 | 5/16-24 x 2 1/4 Hex Caps | (4) | J0156 | 7/16-14 x 2 Hex Caps | (3) |
| J0776 | 1/2-13 Hex Nuts | (6) | J0069 | 5/16-18 x 2 1/2 Hex Caps | (4) | J0184 | 1/2-13 x 1 Hex Caps | (3) |
| J0777 | 1/2-20 Hex Nuts | (6) | J0098 | 3/8-16 x 3/4 Hex Caps | (4) | J0188 | 1/2-13 x 1 1/2 Hex Caps | (3) |
| J0778 | 9/16-12 Hex Nuts | (5) | J0099 | 3/8-24 x 3/4 Hex Caps | (4) | J0189 | 1/2-20 x 1 1/2 Hex Caps | (3) |
| J0779 | 9/16-18 Hex Nuts | (5) | J0102 | 3/8-16 x 1 Hex Caps | (4) | J0192 | 1/2-13 x 2 Hex Caps | (3) |
| J0780 | 5/8-11 Hex Nuts | (5) | J0103 | 3/8-24 x 1 Hex Caps | (4) | J0196 | 1/2-13 x 2 1/2 Hex Caps | (3) |
| J0781 | 5/8-18 Hex Nuts | (5) | J0106 | 3/8-16 x 1 1/4 Hex Caps | (4) | J0197 | 1/2-20 x 2 1/2 Hex Caps | (3) |

Chrome Washers, Body, Hex Sems, Spin Lock Bolts and Pipe Plugs

| Kit Part # | Description | Qty. per card | Kit Part # | Description | Qty. per card | Kit Part # | Description | Qty. per card |
|------------|-------------------|---------------|------------|-----------------------------|---------------|------------|------------------------------|---------------|
| J0852 | #10 Flat Washers | (14) | J0876 | 5/16 AN Washers | (11) | J2229 | 5/16 x 13/16 Pol. Body Bolts | (4) |
| J0854 | 1/4 Flat Washers | (15) | J0877 | 3/8 AN Washers | (10) | J2230 | 5/16 x 1 1/4 Pol. Body Bolts | (3) |
| J0855 | 5/16 Flat Washers | (13) | J0878 | 7/16 AN Washers | (8) | J2255 | 1/4-20 x 7/8 Hex Sems | (4) |
| J0856 | 3/8 Flat Washers | (11) | J0879 | 1/2 AN Washers | (7) | J2256 | 5/16-18 x 1 Hex Sems | (4) |
| J0857 | 7/16 Flat Washers | (10) | J0880 | 9/16 AN Washers | (6) | J2257 | 3/8-16 x 3/4 Hex Sems | (3) |
| J0858 | 1/2 Flat Washers | (9) | J0881 | 5/8 AN Washers | (6) | J2258 | 3/8-16 x 1 Hex Sems | (3) |
| J0859 | 9/16 Flat Washers | (8) | J2250 | 3/8 x 1 1/4 Shock Washers | (4) | J2259 | 3/8-16 1 1/2 Hex Sems | (3) |
| J0860 | 5/8 Flat Washers | (8) | J2251 | 1/2 x 1 1/4 Shock Washers | (4) | J2261 | 1/4-20 x 5/8 Spin Locks | (6) |
| J0865 | 1/4 Lock Washers | (15) | J2252 | 1/2 x 1 7/16 Shock Washers | (4) | J2262 | 5/16-18 x 3/4 Spin Locks | (4) |
| J0866 | 5/16 Lock Washers | (13) | J2253 | 5/8 x 1 1/4 Shock Washers | (4) | J2263 | 5/16-18 x 1 Spin Locks | (4) |
| J0867 | 3/8 Lock Washers | (11) | J2223 | 5/16-18 x1 SS Body Bolts | (1) | J2264 | 5/16-18 X 1 1/4 Spin Locks | (4) |
| J0868 | 7/16 Lock Washers | (10) | J2224 | 14 x 3/4 Body Bolts 3/8 AF | (10) | J2265 | 3/8-16 x 1 Spin Locks | (3) |
| J0869 | 1/2 Lock Washers | (9) | J2225 | 14 x 3/4 Body Bolts 3/8 AF | (9) | J2266 | 5/16-24 x 1 Spin Locks | (5) |
| J0870 | 9/16 Lock Washers | (8) | J2226 | 14 x 3/4 Body Bolts 7/16 AF | (9) | J2267 | 3/8 Pipe Plugs | (3) |
| J0871 | 5/8 Lock Washers | (8) | J2227 | 5/16 x 13/16 Body Bolts | (7) | J2268 | 1/2 Pipe Plugs | (2) |
| J0875 | 1/4 AN Washers | (12) | J2228 | 5/16 x 1 1/4 Body Bolts | (4) | J2269 | 3/4 Pipe Plugs | (2) |

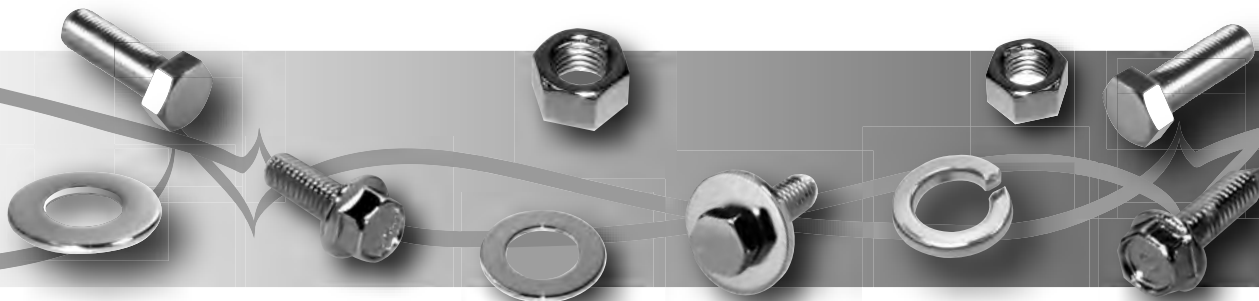



P.O.P Unit Descriptions



FULL FLOOR UNITS

J2POP-2 is a combination of J1POP-3 and J1POP-4 Units

Contains (96) items all in chrome (2)ea. carded kits of the following fasteners:

Chrome Oval Slotted, Phillips Machine and Sheet Metal Screws

| Kit Part # | Description | Qty. per card | Kit Part # | Description | Qty. per card | Kit Part # | Description | Qty. per card |
|------------|-----------------------------|---------------|------------|------------------------------|---------------|------------|------------------------------|---------------|
| J0982 | - 6/32 x 3/8 Oval Slot MS | (5) | J1020 | - 12/24 x 1 Oval Sl. MS | (4) | J1298 | - 8 x 3/4 Oval Phillips SMS | (6) |
| J0983 | - 6/32 x 1/2 Oval Sl. MS | (5) | J1025 | - 1/4-20 x 1 Oval Sl. MS | (6) | J1299 | - 8 x 3/4 Oval Ph. # 6 SMS | (6) |
| J0985 | - 6/32 x 3/4 Oval Sl. MS | (5) | J1036 | - 5/16-24 x 1 Oval Sl. MS | (5) | J1300 | - 8 x 7/8 Oval Ph. SMS | (6) |
| J0986 | - 6/32 x 1 Oval Sl. MS | (5) | J1157 | - 10/32 x 3/8 Oval Ph. MS | (6) | J1301 | - 8 x 7/8 Oval Ph. # 6 SMS | (6) |
| J0992 | - 8/32 x 1/2 Oval Sl. MS | (7) | J1159 | - 10/32 x 1/2 Oval Ph. MS | (6) | J1302 | - 8 x 1 Oval Ph. SMS | (6) |
| J1001 | - 10/24 x 1/2 Oval Sl. MS | (6) | J1162 | - 10/24 x 3/4 Oval Ph. MS | (6) | J1303 | - 8 x 1 Oval Ph. # 6 SMS | (6) |
| J1002 | - 10/32 x 1/2 Oval Sl. MS | (6) | J1163 | - 10/32 x 3/4 Oval Ph. MS | (6) | J1304 | - 8 x 1 1/4 Oval Ph. SMS | (6) |
| J1005 | - 10/24 x 3/4 Oval Sl. MS | (6) | J1166 | - 10/24 x 1 Oval Ph. MS | (6) | J1305 | - 8 x 1 1/4 Oval Ph. # 6 SMS | (5) |
| J1006 | - 10/32 x 3/4 Oval Sl. MS | (6) | J1167 | - 10/32 x 1 Oval Ph. MS | (6) | J1306 | - 8 x 1 1/2 Oval Ph. SMS | (5) |
| J1008 | - 10/32 x 1 Oval Sl. MS | (6) | J1182 | - 1/4-20 x 3/4 Oval Ph. MS | (6) | J1307 | - 8 x 1 1/2 Oval Ph. # 6 SMS | (5) |
| J1010 | - 10/32 x 1 1/4 Oval Sl. MS | (4) | J1183 | - 1/4-20 x 1 Oval Ph. MS | (6) | J1308 | - 8 x 3/4 Oval Ph. # 6 SMS | (4) |
| J1012 | - 10/32 x 1 1/2 Oval Sl. MS | (4) | J1186 | - 1/4-20 x 1 1/2 Oval Ph. MS | (6) | J1309 | - 8 x 3/4 Oval Ph. SMS | (6) |
| J1013 | - 10/32 x 1 3/4 Oval Sl. MS | (4) | J1294 | - 8 x 1/2 Oval Ph. SMS | (6) | J1310 | - 8 x 2 Oval Ph. SMS | (5) |
| J1014 | - 10/32 x 2 Oval Sl. MS | (4) | J1295 | - 8 x 1/2 Oval Ph. SMS | (6) | J1311 | - 8 x 2 Oval Ph. # 6 SMS | (4) |
| J1017 | - 12/24 x 1/2 Oval Sl. MS | (4) | J1296 | - 8 x 5/8 Oval Ph. SMS | (6) | J1315 | - 10 x 3/4 Oval Ph. SMS | (7) |
| J1019 | - 12/24 x 3/4 Oval Sl. MS | (4) | J1297 | - 8 x 5/8 Oval Ph. #6 SMS | (6) | J1317 | - 12 x 1 Oval Ph. SMS | (4) |

Chrome Button Heads, Lock Nuts, Carriage Bolts and Super Washers

| Kit Part # | Description | Qty. per card | Kit Part # | Description | Qty. per card | Kit Part # | Description | Qty. per card |
|------------|-----------------------------|---------------|------------|----------------------------|---------------|------------|------------------------------|---------------|
| J0535 | - 8/32 x 1/2 Button Heads | (4) | J0618 | - 3/8-16 x 1 1/2 Btn. Hds. | (2) | J0891 | - 1/4 x 1 1/2 Carriage | (4) |
| J0546 | - 10/24 x 1/2 Btn. Hds. | (4) | J0793 | - 1/4-20 Lock Nuts | (8) | J0901 | - 5/16 x 1 Carriage | (4) |
| J0547 | - 10/32 x 1/2 Btn. Hds. | (4) | J0794 | - 1/4-28 Lock Nuts | (8) | J0903 | - 5/16 x 1 1/2 Carriage | (4) |
| J0550 | - 10/24 x 3/4 Btn. Hds. | (4) | J0795 | - 5/16-18 Lock Nuts | (8) | J0914 | - 3/8-16 x 1 Carriage | (4) |
| J0551 | - 10/32 x 3/4 Btn. Hds. | (4) | J0796 | - 5/16-24 Lock Nuts | (8) | J0917 | - 3/8-16 x 2 Carriage | (4) |
| J0564 | - 1/4-20 x 1/2 Btn. Hds. | (4) | J0797 | - 3/8-16 Lock Nuts | (6) | J0918 | - 3/8 x 2 1/2 Carriage | (3) |
| J0568 | - 1/4-20 x 3/4 Btn. Hds. | (4) | J0798 | - 3/8-24 Lock Nuts | (6) | J0926 | - 7/16-14 x 1 1/4 Carriage | (3) |
| J0572 | - 1/4-20 x 1 Btn. Hds. | (4) | J0799 | - 7/16-14 Lock Nuts | (5) | J0928 | - 7/16-14 x 1 3/4 Carriage | (3) |
| J0574 | - 1/4-20 x 1 1/4 Btn. Hds. | (4) | J0800 | - 7/16-20 Lock Nuts | (5) | J0938 | - 1/2-13 x 1 3/4 Carriage | (3) |
| J0588 | - 5/16-18 x 3/4 Btn. Hds. | (4) | J0801 | - 1/2-13 Lock Nuts | (5) | J2271 | - 3/16 x 1 Super Washers | (5) |
| J0589 | - 5/16-24 x 3/4 Btn. Hds. | (4) | J0802 | - 1/2-20 Lock Nuts | (5) | J2272 | - 1/4 x 1 Super Washers | (5) |
| J0592 | - 5/16-18 x 1 Btn. Hds. | (4) | J0803 | - 9/16-12 Lock Nuts | (4) | J2273 | - 5/16 x 1 1/8 Super Washers | (5) |
| J0593 | - 5/16-24 x 1 Btn. Hds. | (4) | J0804 | - 9/16-18 Lock Nuts | (4) | J2274 | - 5/16 x 1 1/2 Super Washers | (4) |
| J0596 | - 5/16-18 x 1 1/2 Btn. Hds. | (3) | J0805 | - 5/8-11 Lock Nuts | (4) | J2275 | - 3/8 x 1 1/2 Super Washers | (4) |
| J0610 | - 3/8-16 x 3/4 Btn. Hds. | (4) | J0806 | - 5/16-16 Lock Nuts | (4) | J2276 | - 7/16 x 1 Super Washers | (6) |
| J0614 | - 3/8-16 x 1 Btn. Hds. | (4) | J0888 | - 1/4 x 3/4 Carriage w/HN | (4) | J2277 | - 1/2 x 1 1/4 Super Washers | (6) |

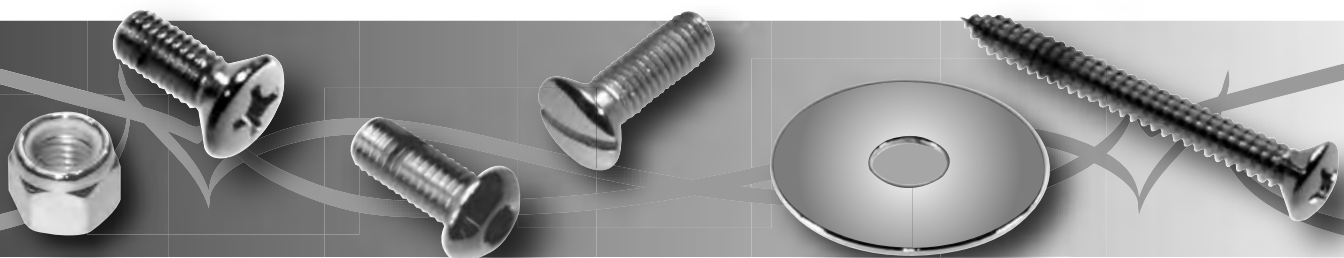



P.O.P. Unit Descriptions

FULL FLOOR UNITS



J2POP-3 is a Product Display Unit of Polished Stainless Steel
Contains (96) items of (1) ea. carded kits of the following fasteners:

Polished Stainless Steel Hex Caps, Hex Nuts, Button Head Allen Screws, Flat Washers, Nylon Lock Nuts and Oval Phillips Sheet Metal Screws

| Kit Part # | Description | Qty. per card | Kit Part # | Description | Qty. per card |
|------------|----------------------------------|------------------|------------|---|------------------|
| J7000 | - 1/4-20 x 1/2 Hex Caps | (7) | J7048 | - 10/32 x 1/2 Button Head Allens | (8) |
| J7001 | - 1/4-20 x 3/4 Hex Caps | (7) | J7049 | - 10/24 x 3/4 Button Head Allens | (7) |
| J7002 | - 1/4-20 x 1 Hex Caps | (7) | J7050 | - 10/32 x 3/4 Button Head Allens | (7) |
| J7003 | - 5/16-18 x 5/8 Hex Caps | (6) | J7051 | - 1/4-20 x 1/2 Button Head Allens | (6) |
| J7004 | - 5/16-18 x 3/4 Hex Caps | (6) | J7052 | - 1/4-20 x 3/4 Button Head Allens | (6) |
| J7005 | - 5/16-18 x 1 Hex Caps | (6) | J7053 | - 1/4-20 x 1 Button Head Allens | (6) |
| J7006 | - 5/16-18 x 1 1/4 Hex Caps | (6) | J7054 | - 1/4-20 x 1 1/4 Button Head Allens | (5) |
| J7007 | - 5/16-18 x 2 Hex Caps | (5) | J7055 | - 5/16-18 x 3/4 Button Head Allens | (5) |
| J7008 | - 5/16-18 x 2 1/2 Hex Caps | (4) | J7056 | - 5/16-24 x 3/4 Button Head Allens | (2) |
| J7009 | - 3/8-16 x 3/4 Hex Caps | (6) | J7057 | - 5/16-18 x 1 Button Head Allens | (4) |
| J7010 | - 3/8-16 x 1 Hex Caps | (6) | J7058 | - 5/16-24 x 1 Button Head Allens | (2) |
| J7011 | - 3/8-16 x 1 1/4 Hex Caps | (5) | J7059 | - 5/16-18 x 1 1/2 Button Head Allens | (4) |
| J7012 | - 3/8-16 x 1 1/2 Hex Caps | (4) | J7060 | - 3/8-16 x 3/4 Button Head Allens | (4) |
| J7013 | - 3/8-16 x 1 3/4 Hex Caps | (4) | J7061 | - 3/8-16 x 1 Button Head Allens | (3) |
| J7014 | - 3/8-16 x 2 Hex Caps | (4) | J7062 | - 3/8-16 x 1 1/2 Button Head Allens | (3) |
| J7015 | - 3/8-16 x 2 1/4 Hex Caps | (4) | J7063 | - 3/16 Flat Washers | (10) |
| J7016 | - 3/8-16 x 2 1/2 Hex Caps | (3) | J7064 | - 1/4 Flat Washers | (10) |
| J7017 | - 3/8-16 x 2 3/4 Hex Caps | (3) | J7065 | - 5/16 Flat Washers | (9) |
| J7018 | - 3/8-16 x 3 Hex Caps | (3) | J7066 | - 3/8 Flat Washers | (8) |
| J7019 | - 7/16-14 x 1 Hex Caps | (4) | J7067 | - 7/16 Flat Washers | (7) |
| J7020 | - 7/16-14 x 1 1/4 Hex Caps | (4) | J7068 | - 1/2 Flat Washers | (6) |
| J7021 | - 7/16-14 x 2 Hex Caps | (3) | J7069 | - 5/8 Flat Washers | (5) |
| J7022 | - 1/2-13 x 1 Hex Caps | (3) | J7070 | - 1/4-20 Nylon Lock Nuts | (4) |
| J7023 | - 1/2-13 x 1 1/2 Hex Caps | (3) | J7071 | - 1/4-28 Nylon Lock Nuts | (4) |
| J7024 | - 1/2-13 x 2 Hex Caps | (3) | J7072 | - 5/16-18 Nylon Lock Nuts | (4) |
| J7025 | - 1/2-13 x 2 1/2 Hex Caps | (2) | J7073 | - 5/16-24 Nylon Lock Nuts | (4) |
| J7026 | - 5/16-24 x 3/4 Hex Caps | (6) | J7074 | - 3/8-16 Nylon Lock Nuts | (3) |
| J7027 | - 5/16-24 x 2 1/4 Hex Caps | (4) | J7075 | - 3/8-24 Nylon Lock Nuts | (3) |
| J7028 | - 3/8-24 x 3/4 Hex Caps | (6) | J7076 | - 7/16-14 Nylon Lock Nuts | (3) |
| J7029 | - 3/8-24 x 1 Hex Caps | (5) | J7077 | - 7/16-20 Nylon Lock Nuts | (5) |
| J7030 | - 1/2-20 x 1 1/2 Hex Caps | (2) | J7078 | - 1/2-13 Nylon Lock Nuts | (3) |
| J7031 | - 1/2-20 x 2 1/2 Hex Caps | (2) | J7079 | - 1/2-20 Nylon Lock Nuts | (2) |
| J7032 | - 10/24 Hex Nuts | (4) | J7080 | - 5/8-11 Nylon Lock Nuts | (2) |
| J7033 | - 1/4-20 Hex Nuts | (4) | J7081 | - 5/8-18 Nylon Lock Nuts | (2) |
| J7034 | - 5/16-18 Hex Nuts | (4) | J7082 | - #8 x 1/2 Oval Phillips Sheet Metal Screws | (8) |
| J7035 | - 3/8-16 Hex Nuts | (4) | J7083 | - #8 x 3/4 Oval Phillips Sheet Metal Screws | (8) |
| J7036 | - 7/16-14 Hex Nuts | (3) | J7084 | - #8 x 1 Oval Phillips Sheet Metal Screws | (8) |
| J7037 | - 1/2-13 Hex Nuts | (3) | J7085 | - #8 x 1 1/4 Oval Phillips Sheet Metal Screws | (8) |
| J7038 | - 5/8-11 Hex Nuts | (2) | J7086 | - 8 x 3/4 #6 Oval Phillips Sheet Metal Screws | (6) |
| J7039 | - 10/32 Hex Nuts | (4) | J7087 | - 8 x 1 #6 Oval Phillips Sheet Metal Screws | (6) |
| J7040 | - 1/4-28 Hex Nuts | (4) | J7088 | - 8 x 1 1/4 #6 Oval Phillips Sheet Metal Screws | (6) |
| J7041 | - 5/16-24 Hex Nuts | (4) | J7089 | - 8 x 1 1/2 #6 Oval Phillips Sheet Metal Screws | (6) |
| J7042 | - 3/8-24 Hex Nuts | (4) | J7090 | - 8/32 x 3/4 Oval Phillips Sheet Metal Screws | (8) |
| J7043 | - 7/16-20 Hex Nuts | (3) | J7091 | - 10/32 x 1/2 Oval Phillips Sheet Metal Screws | (8) |
| J7044 | - 1/2-20 Hex Nuts | (3) | J7092 | - 10/32 x 3/4 Oval Phillips Sheet Metal Screws | (8) |
| J7045 | - 5/8-18 Hex Nuts | (2) | J7093 | - 10/32 x 1 Oval Phillips Sheet Metal Screws | (8) |
| J7046 | - 8/32 x 1/2 Button Head Allens | (8) | J7094 | - 10/24 x 3/4 Oval Phillips Sheet Metal Screws | (8) |
| J7047 | - 10/24 x 1/2 Button Head Allens | (8) | J7095 | - 12/24 x 1 Oval Phillips Sheet Metal Screws | (6) |

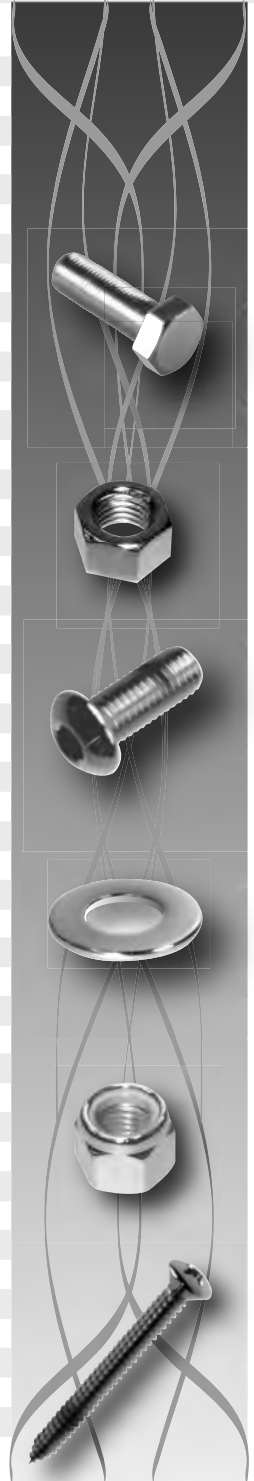

Notes



Notes



Notes



Notes



Notes





In Memory of our Company Founders



Ralph and Beverly Simons

When only the very BEST will do, Demand what the Pro's use...

Gardner-Westcott



2015 © Copyright Gardner-Westcott Company 10110 Six Mile Road Northville, Michigan 48168-9426

Call us toll-free at 1-800-521-9805 or (248)-305-5100 Fax (800)-871-5110 Shop on line at <http://www.gardner-westcott.com>